

КАРТОТЕКА ОРИГАМИ

Оригами для детей - отличный способ развить логическое и пространственное мышление, стимулировать творческую активность путем активации мыслительных процессов.

Данная картотека поможет родителям и педагогам помочь детям освоить технику оригами, начиная с простейшего, и в тоже время интересного и игрового материала.

Каждую фигурку можно:

1. сделать в подарок,
2. сделать объектом объемной картины,
3. сделать игрушкой для сюжетной, режиссерской игры
4. сделать персонажем театрализации или своей авторской сказки.

Творческих успехов.

ОРИГАМИ «СОБАКА»

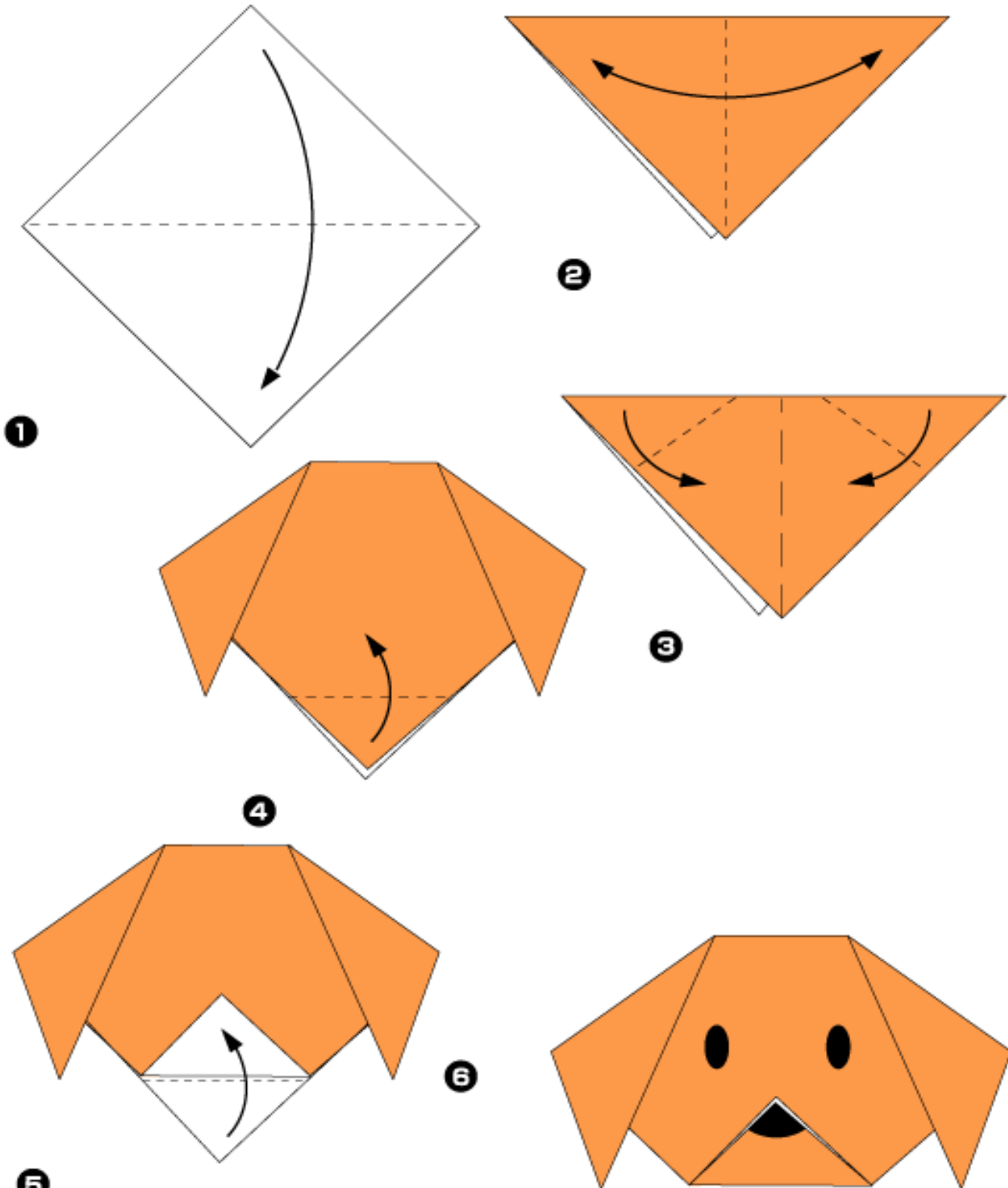

*Traditional
Diagram:Fumiaki Shingu

ОРИГАМИ «КИТ»

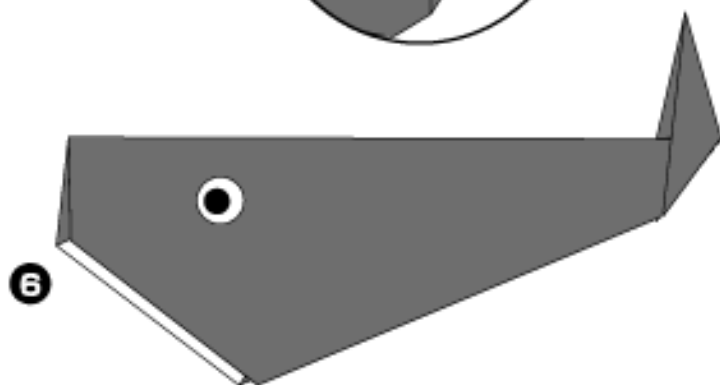
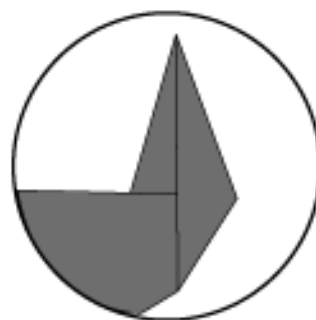
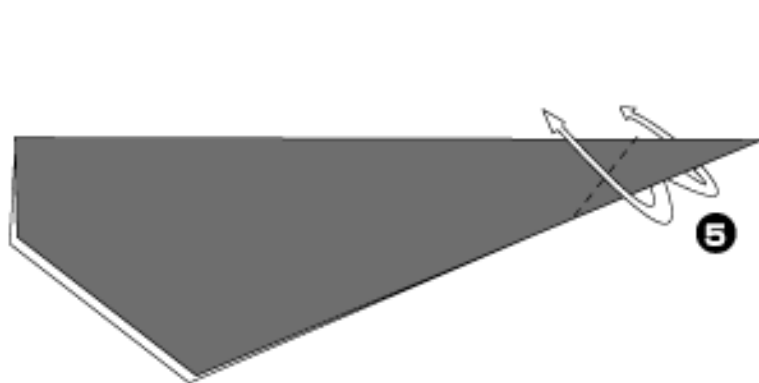
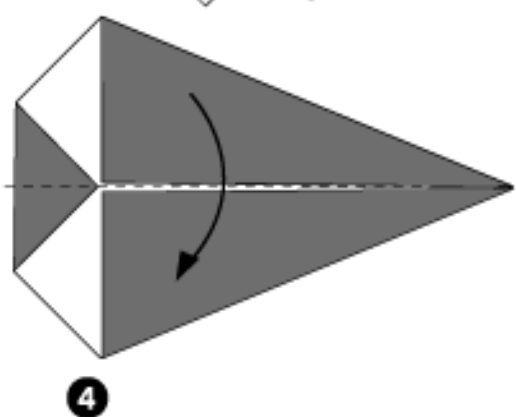
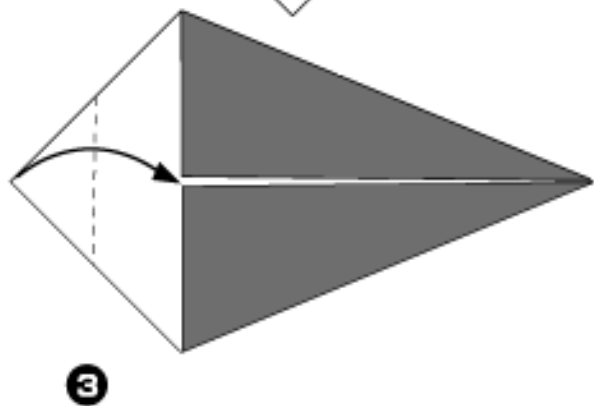
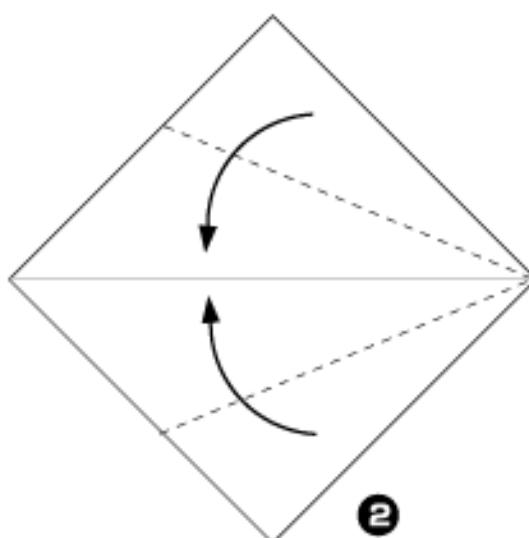
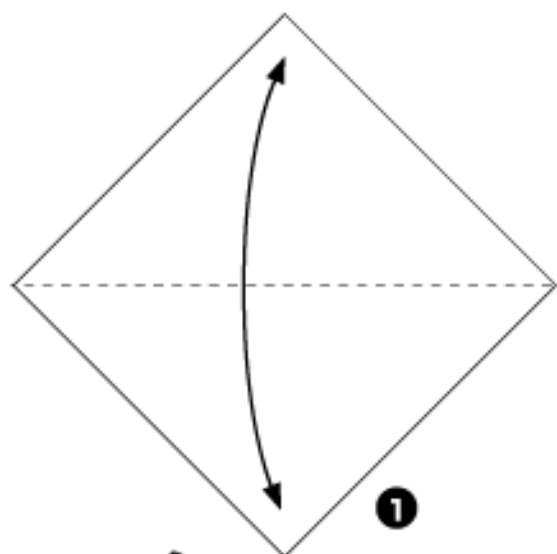

Оригами «ЛОШАДЬ»

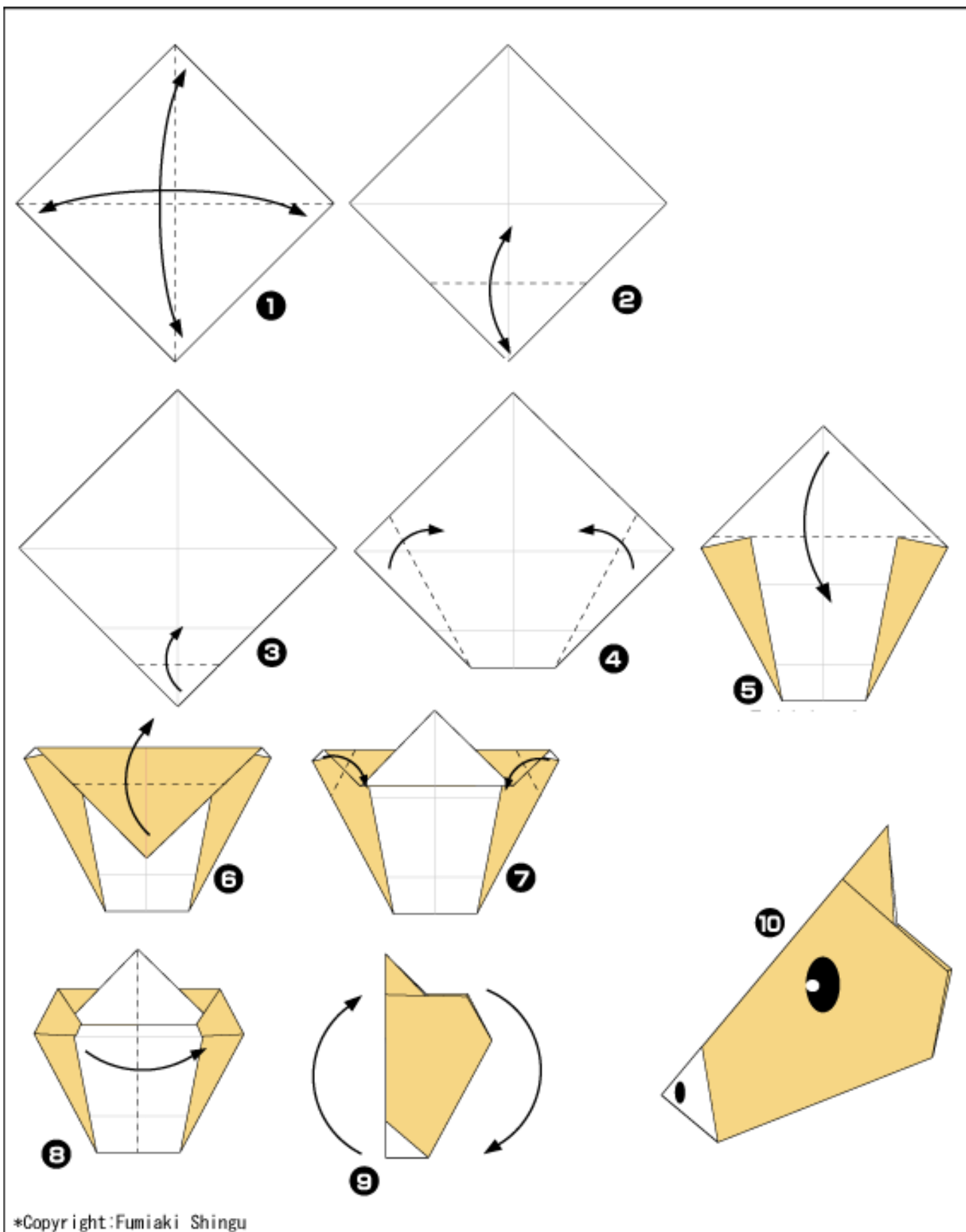

ОРИГАМИ «РЫБА»

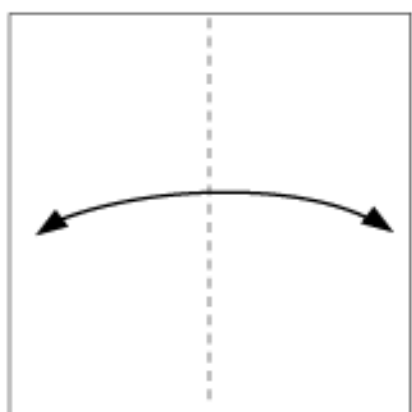

1

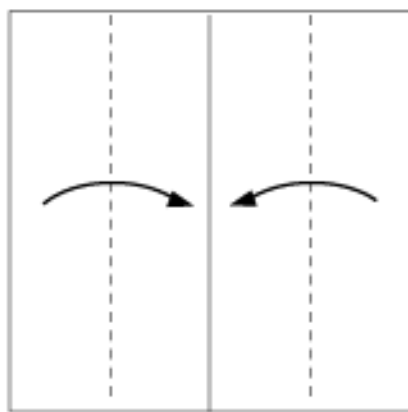

2



3

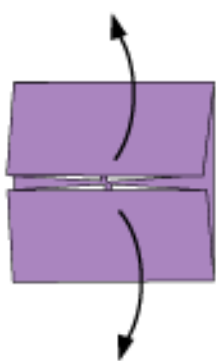

4

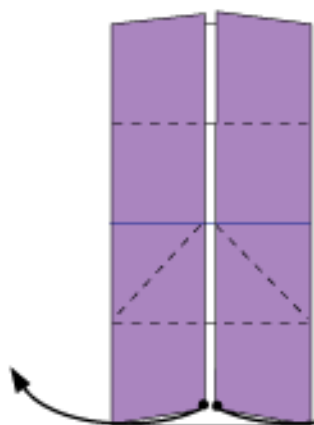

5

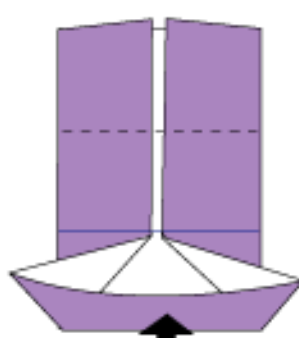

6

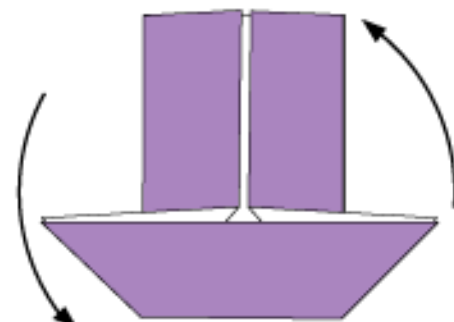

7

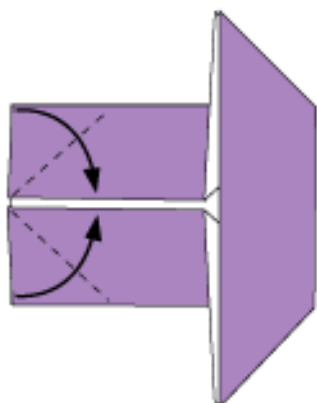

8

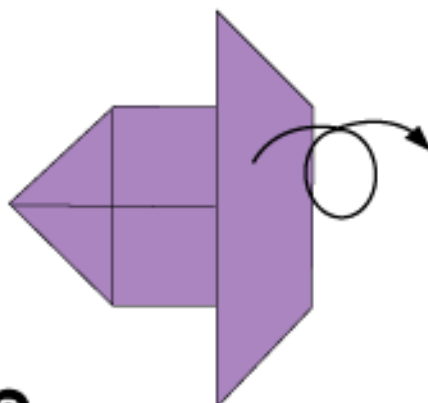

9

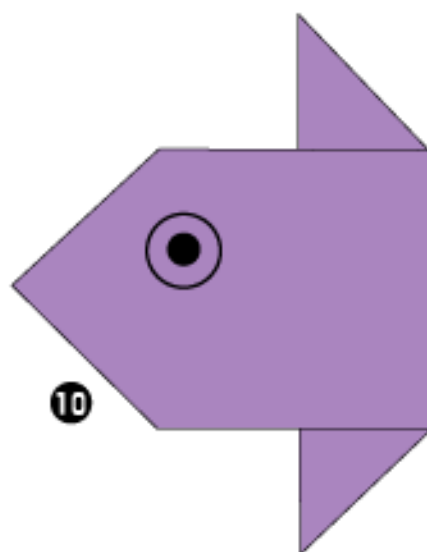

10

ОРИГАМИ «ЯХТА»

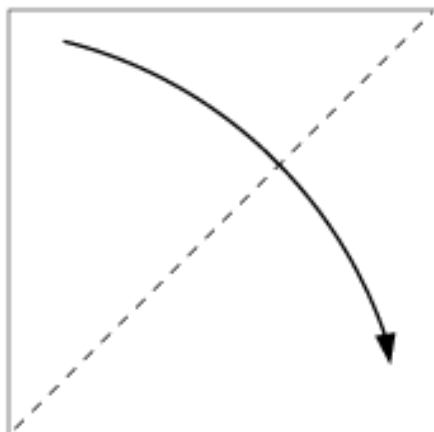

1

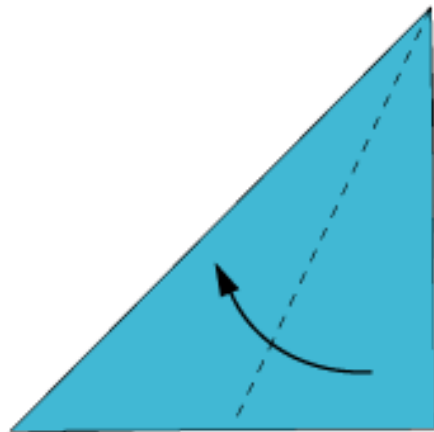

2

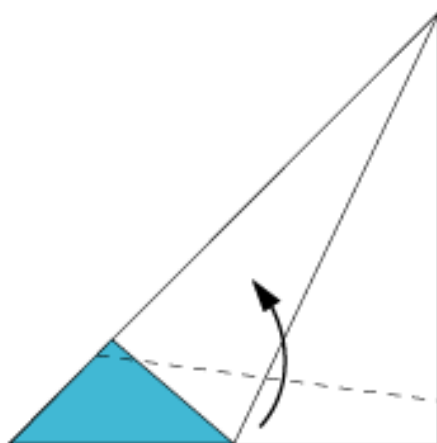

3

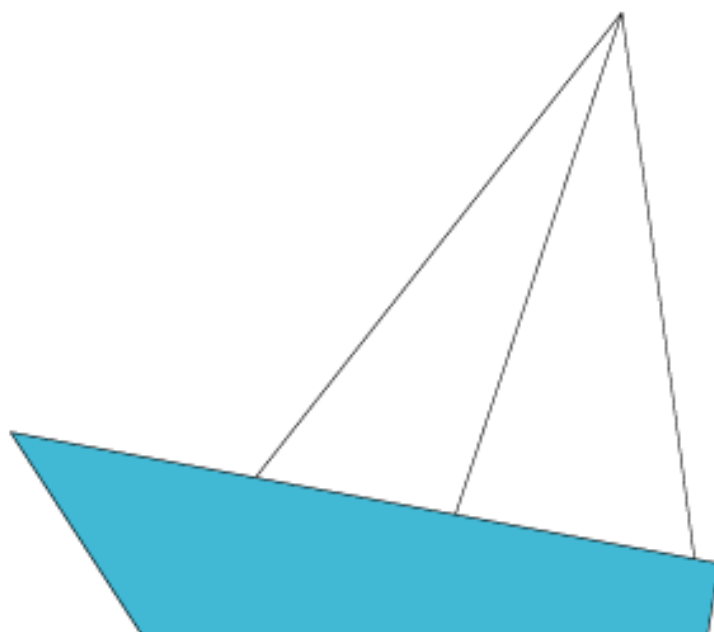

4

ОРИГАМИ «ТЮЛЬПАН»

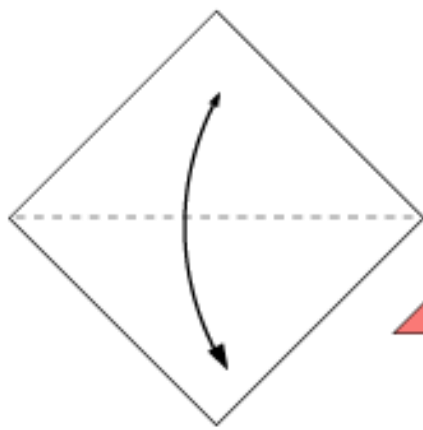

1

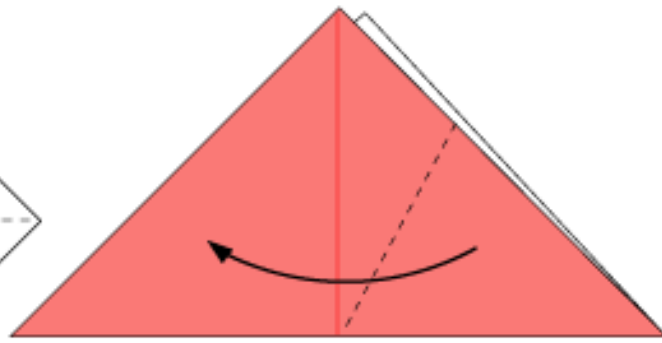

2

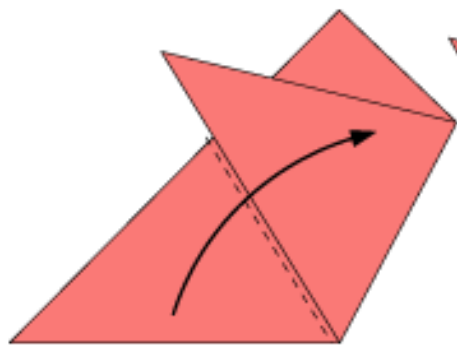

3

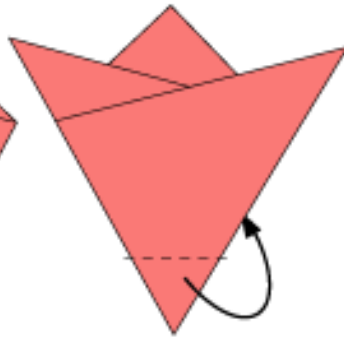

4

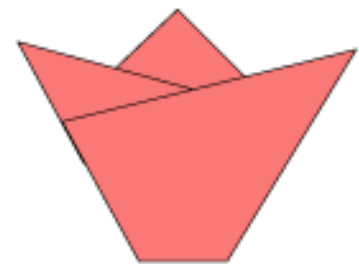

5

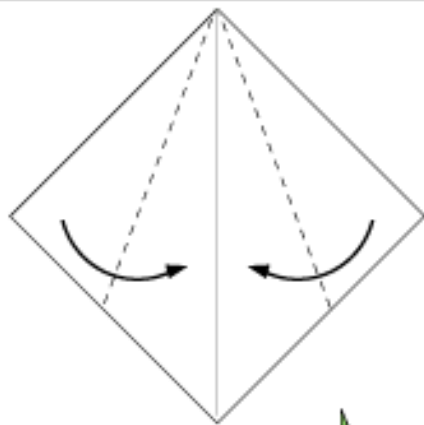

1

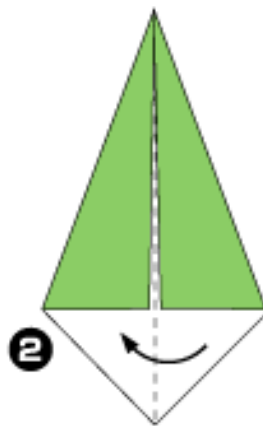

2



3

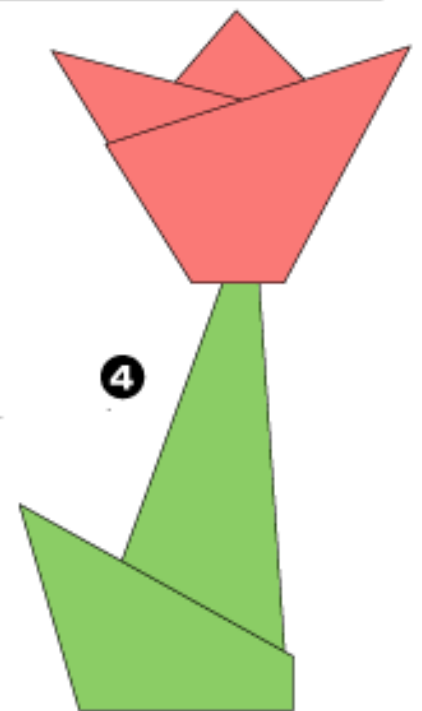

4

ОРИГАМИ «ЦВЕТОК»

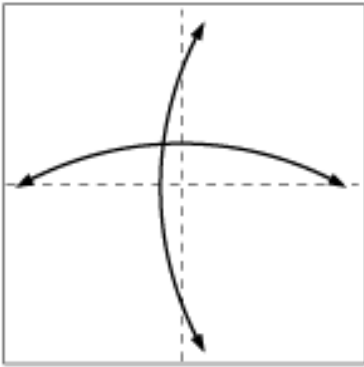

1

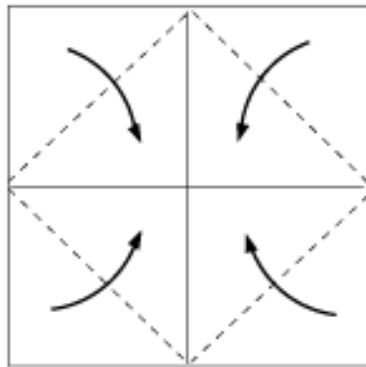

2

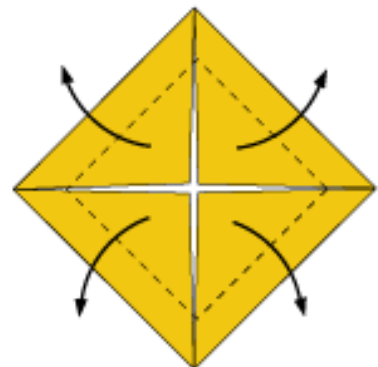

3

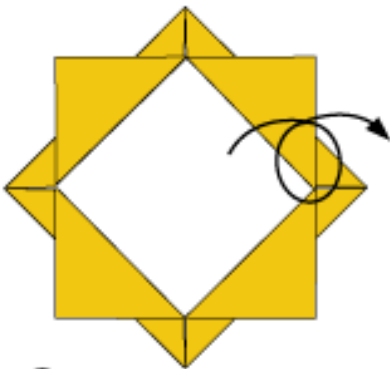

4

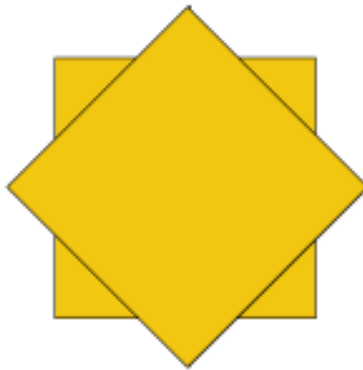

5

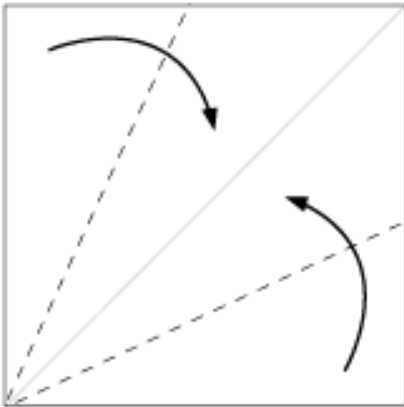

1

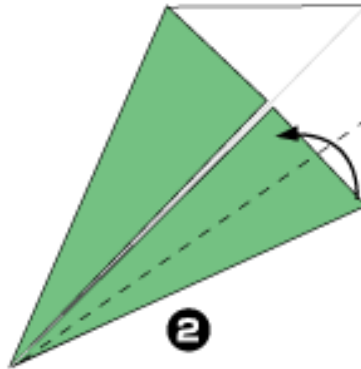

2

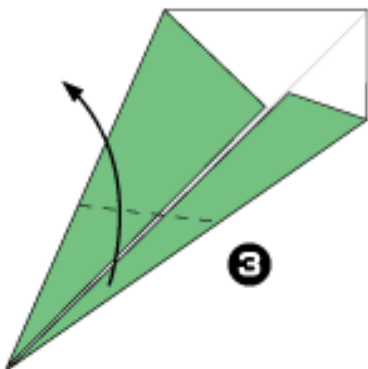

3

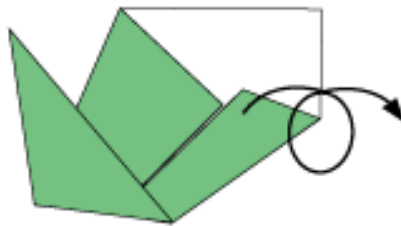

4

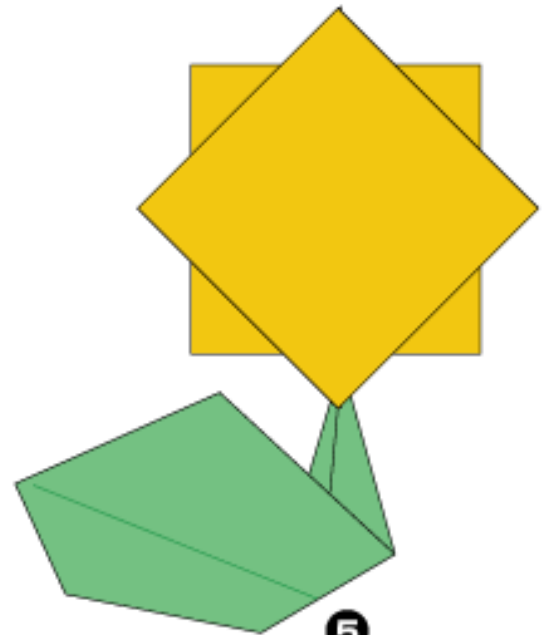

5

ОРИГАМИ «АКУЛА»

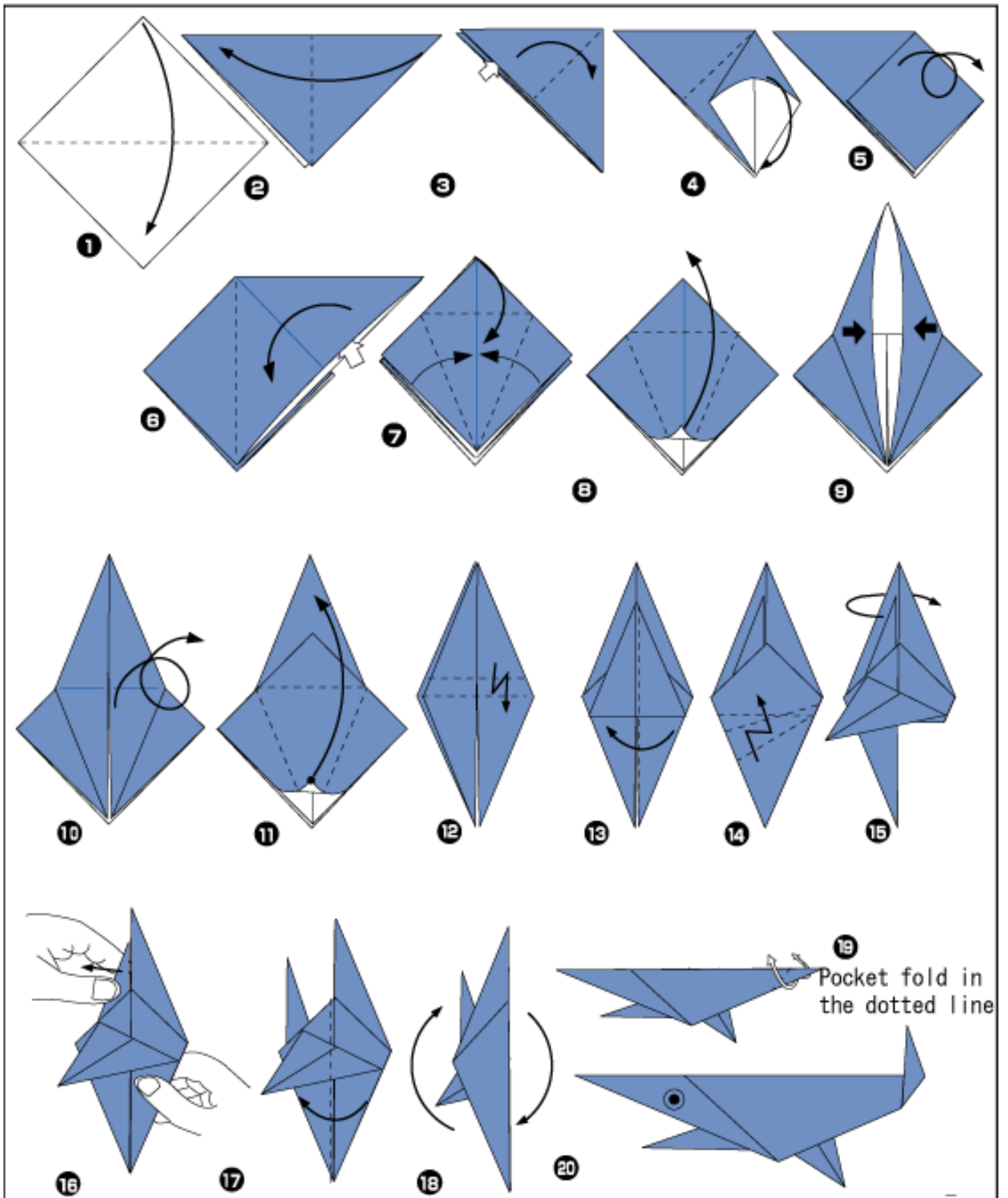

19 Pocket fold in the dotted line

ОРИГАМИ «ЧЕРЕПАХА»

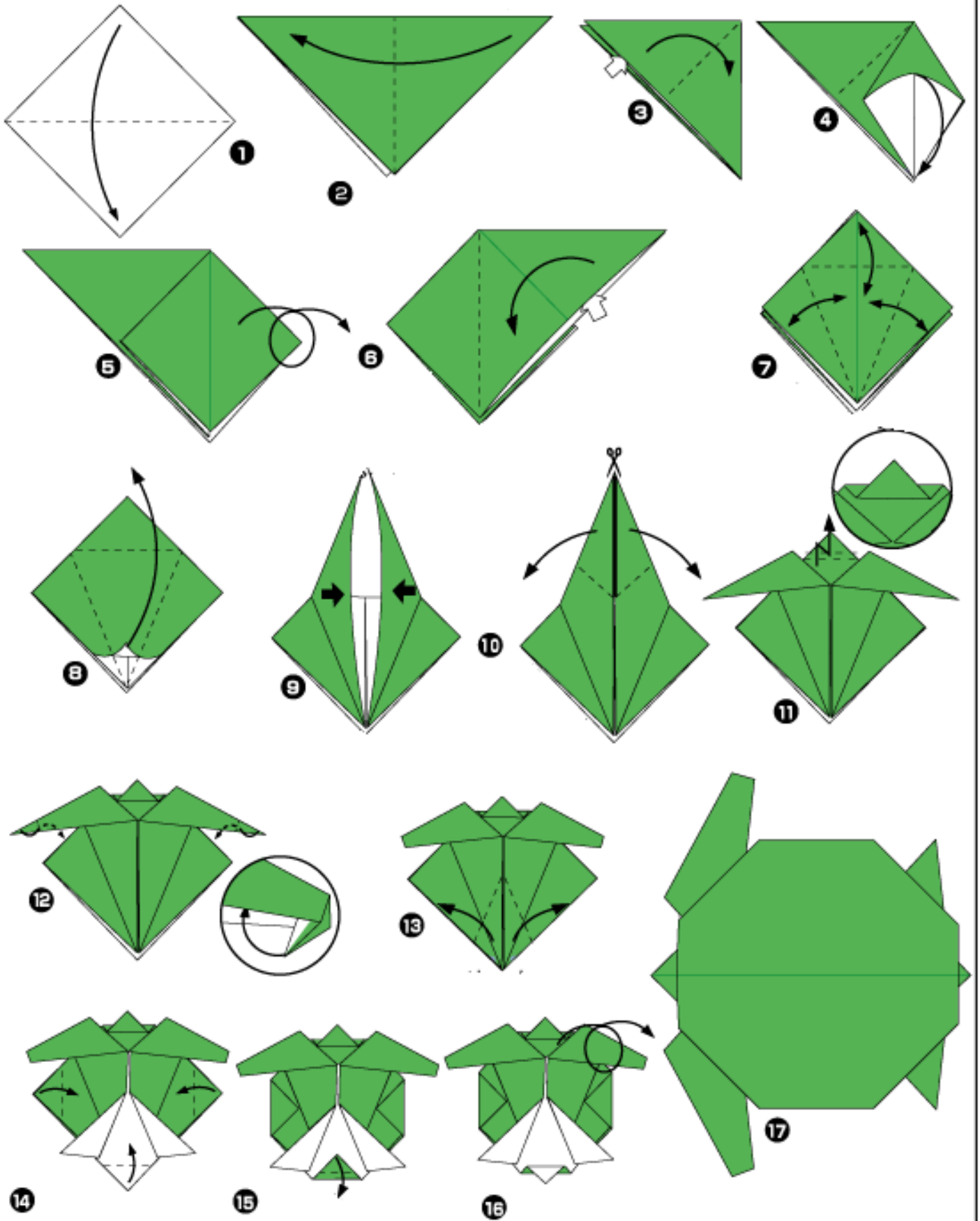

ОРИГАМИ «КРАБ»

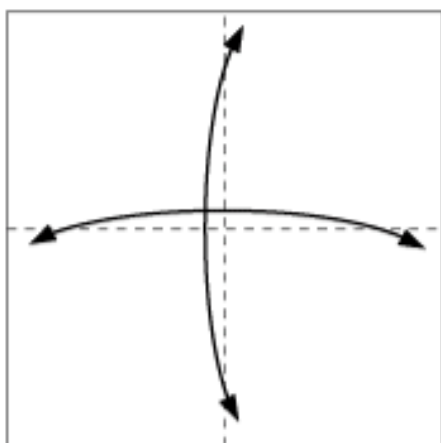

1

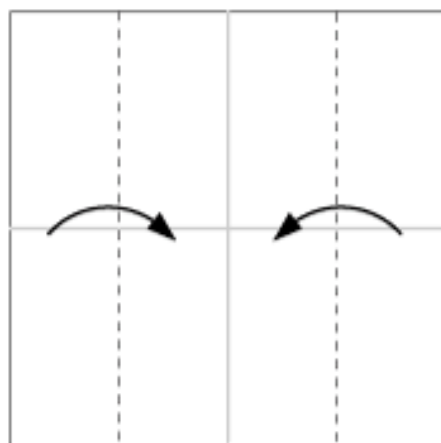

2

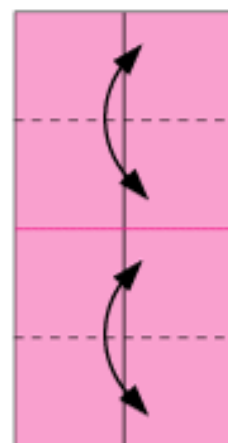

3

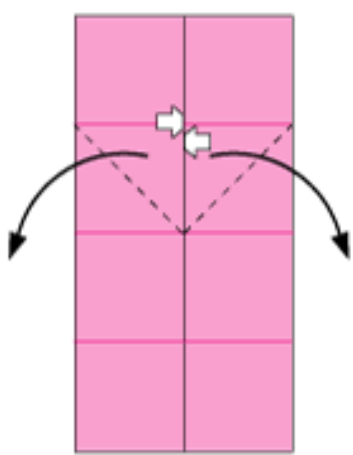

4

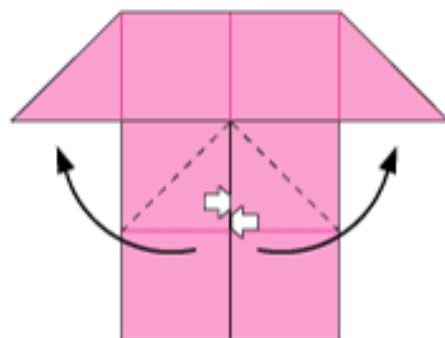
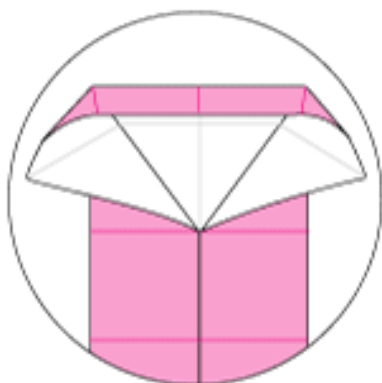

5

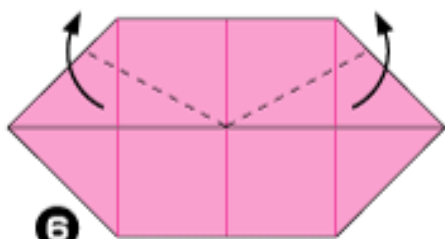

6

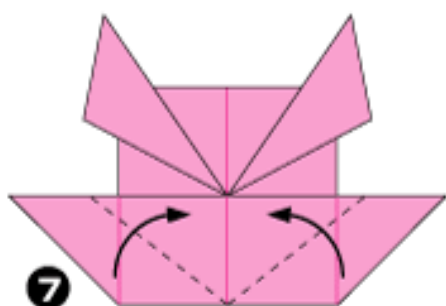

7

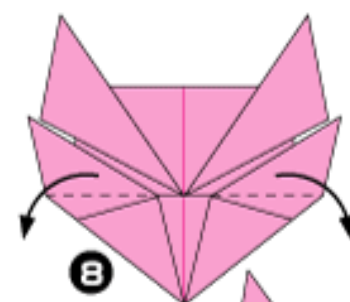

8

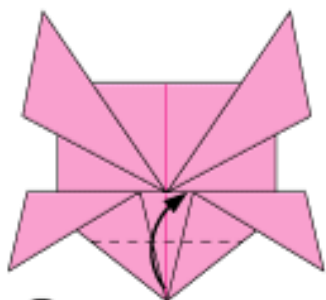

9

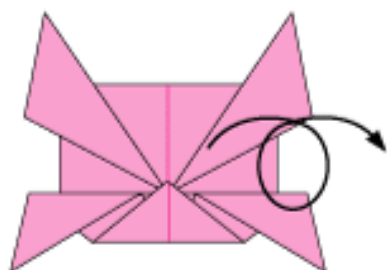

10

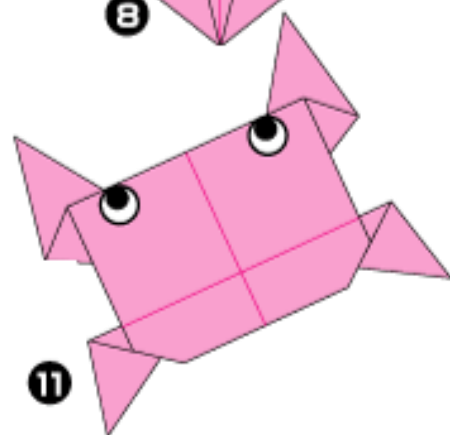

11

ОРИГАМИ «РЫБА»

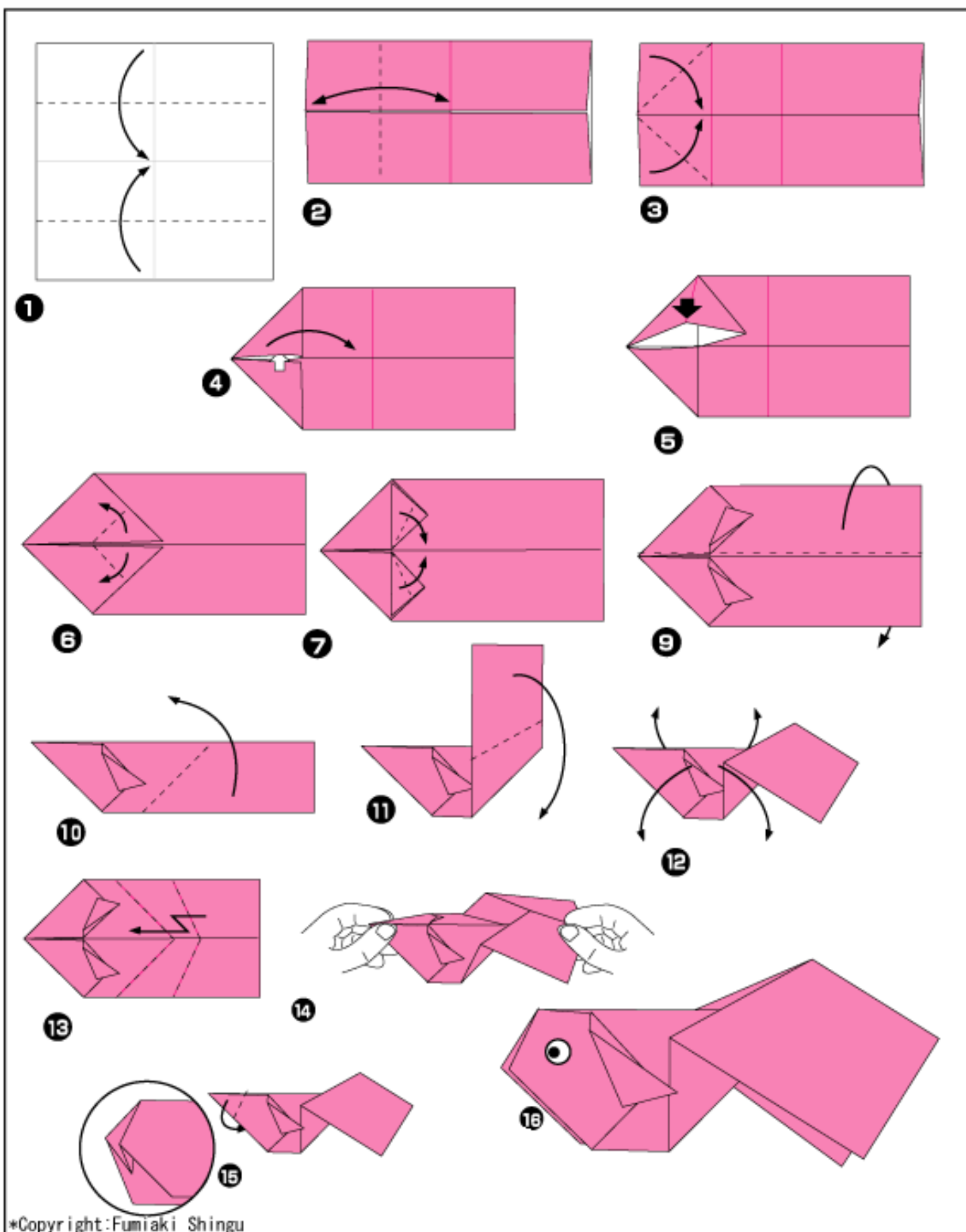

ОРИГАМИ «КАСАТКА»

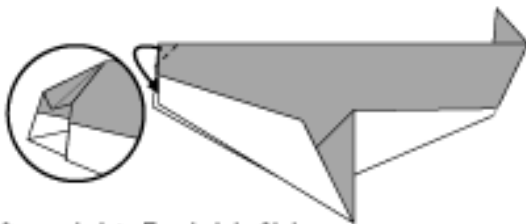
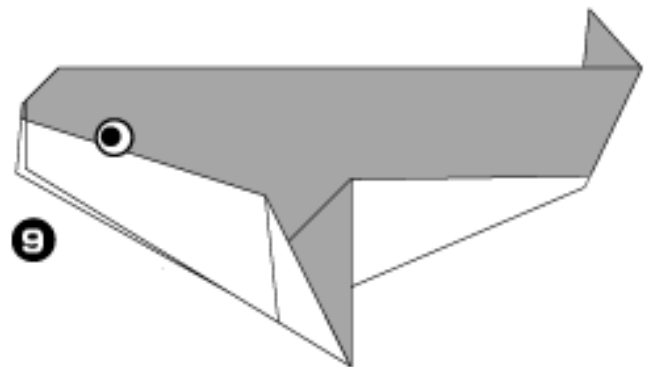
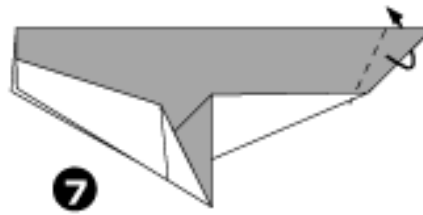
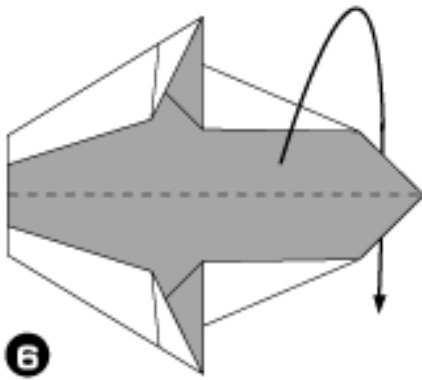
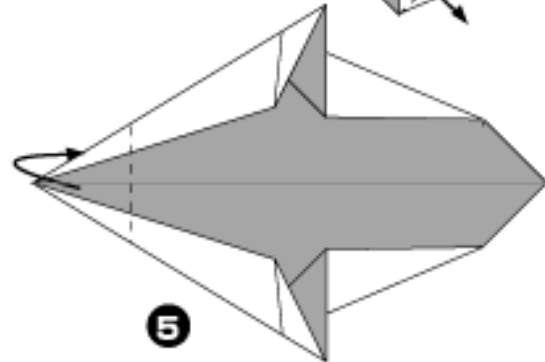
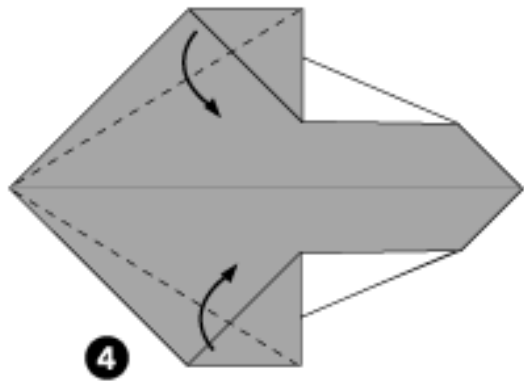
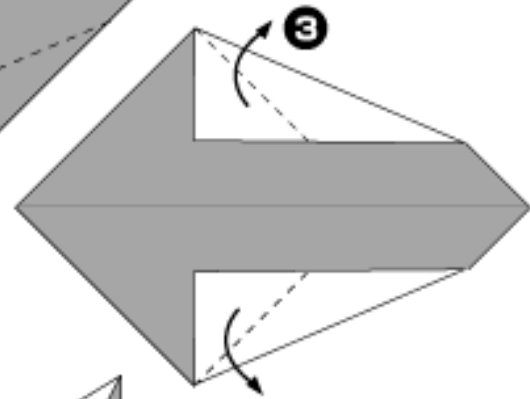
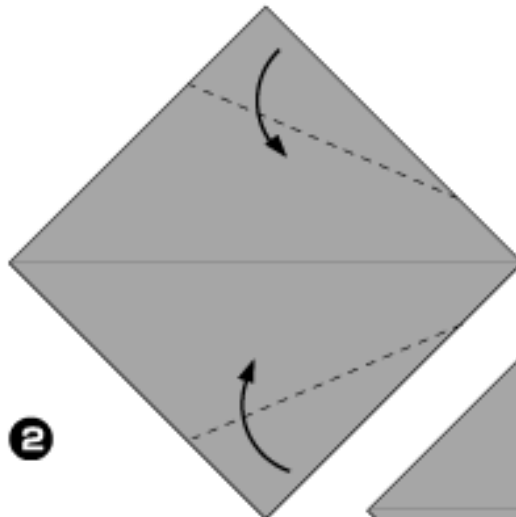
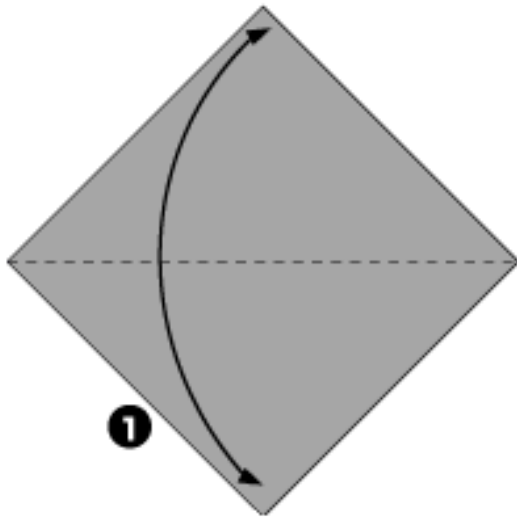

«ВОЗДУШНЫЙ ШАР»

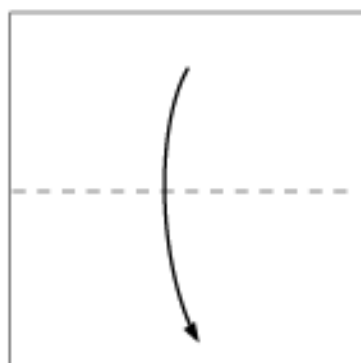

1

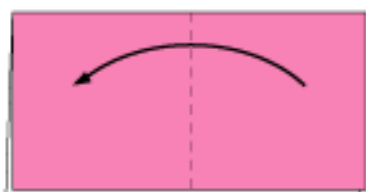

2



3

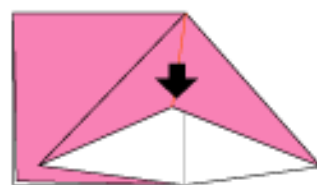

4

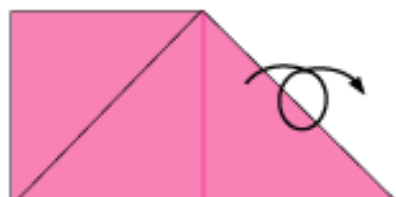

5

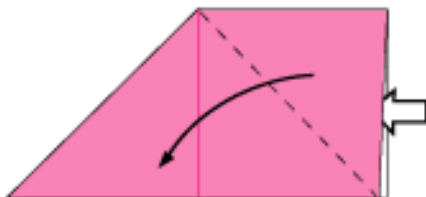

6

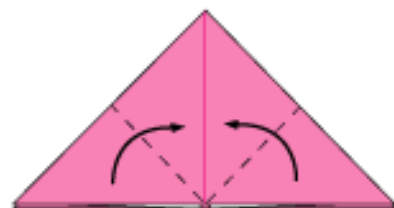

7

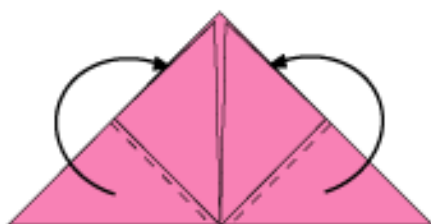

8

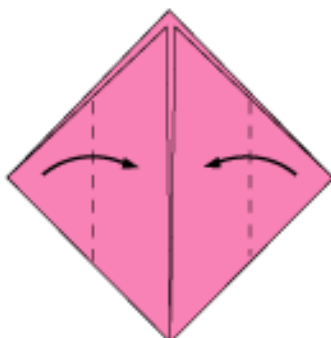

9

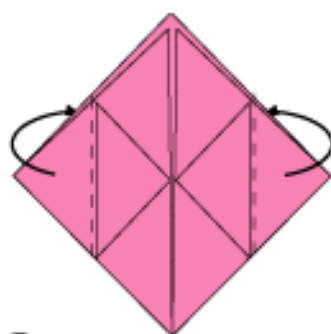

10



11

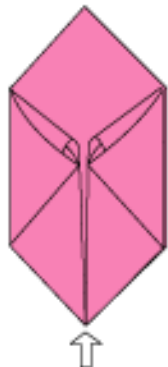

12

13

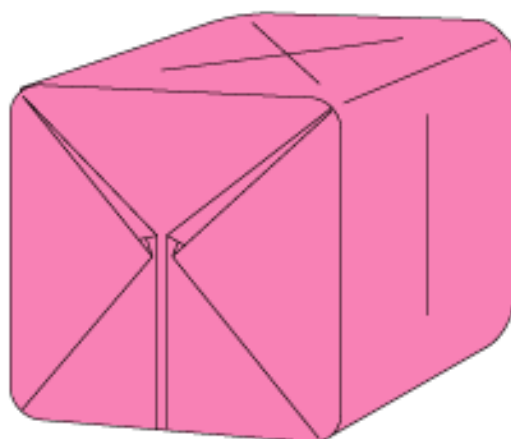

*Traditional
Diagram:Fumiaki Shingu

«ЖУРАВЛИК»

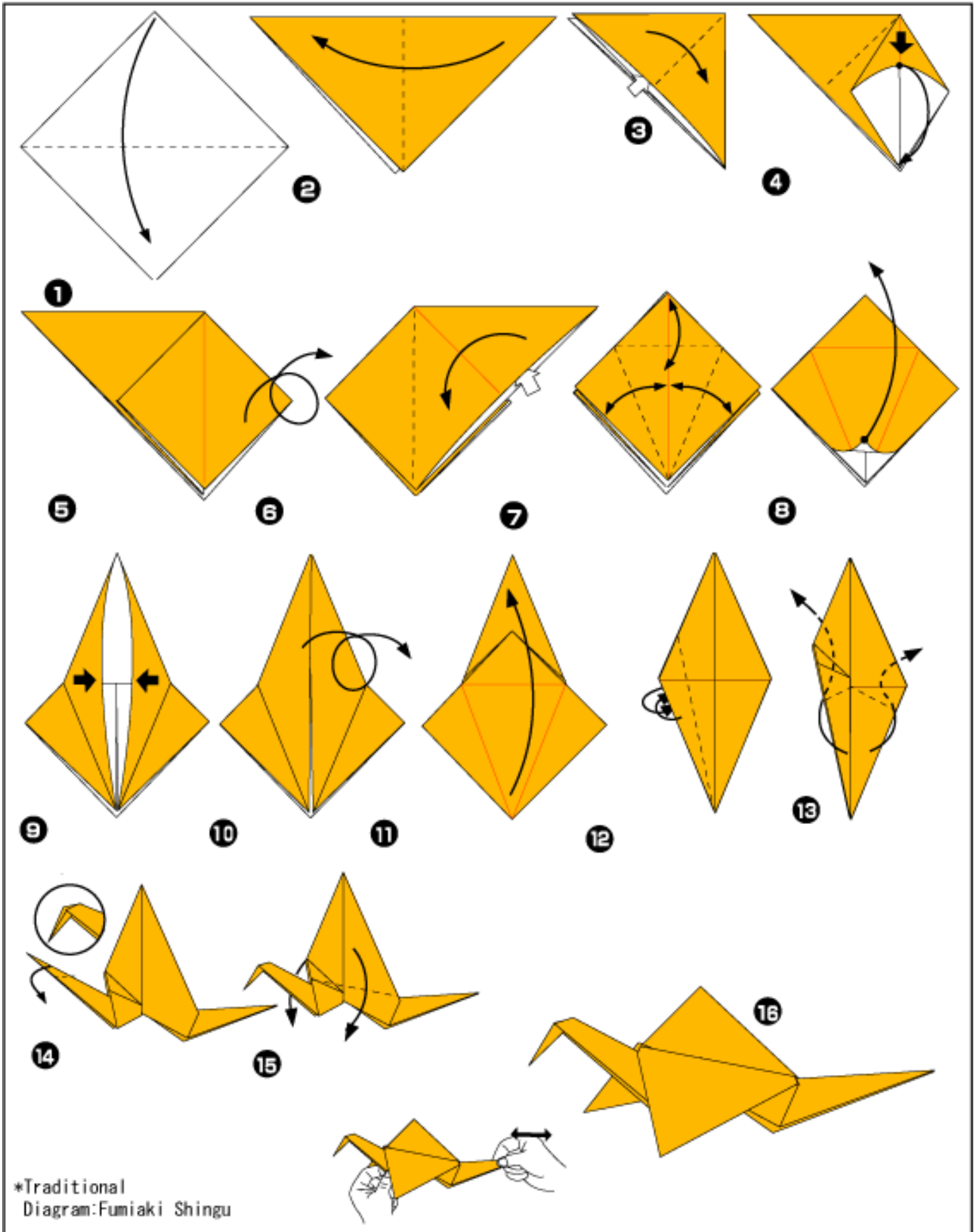

«ЛОДКА»

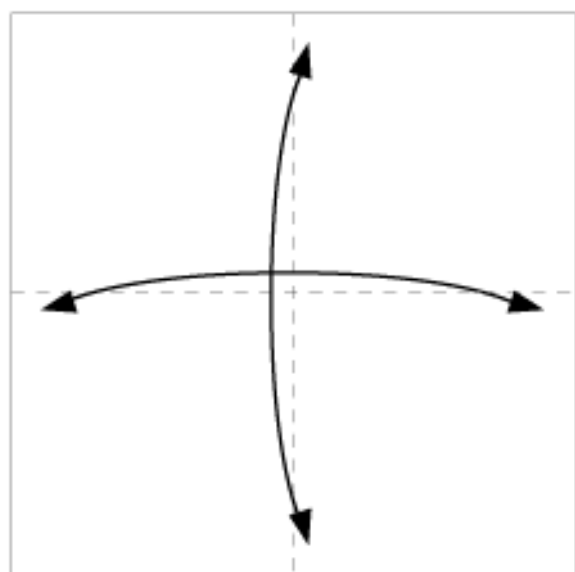

1

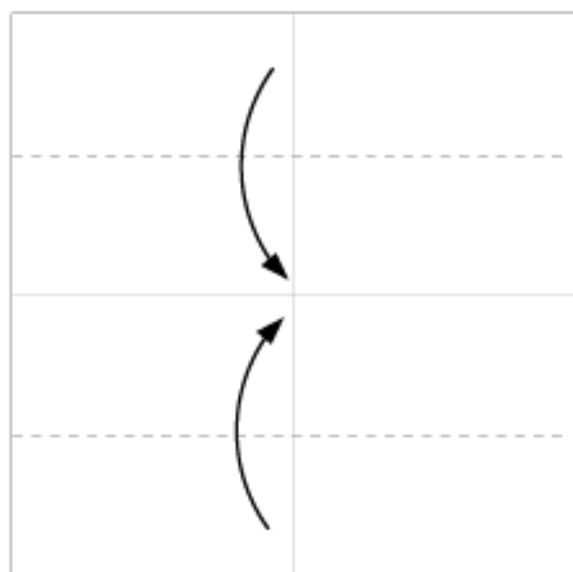

2



3

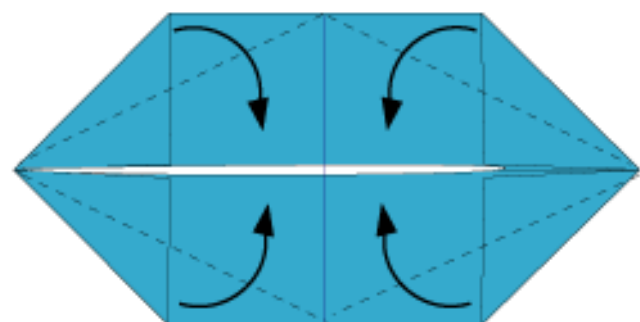

4

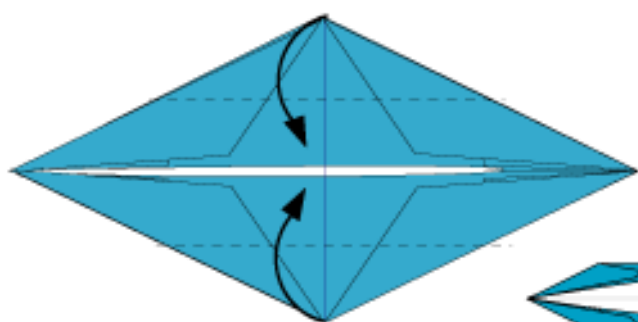

5



6

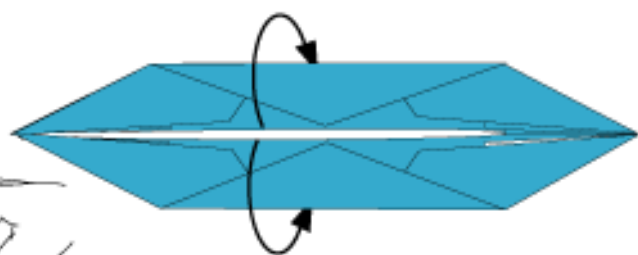

7

*Traditional
Diagram: Fumiaki Shingu

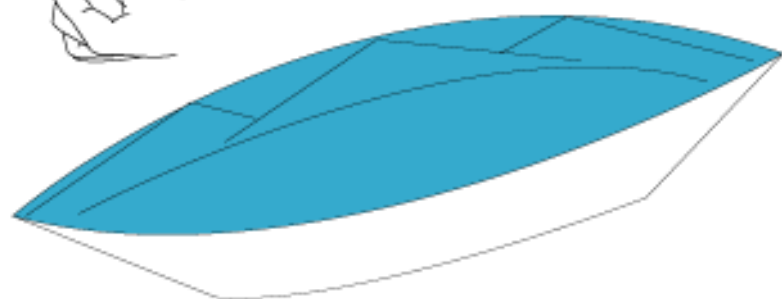

«ЛЯГУШКА»

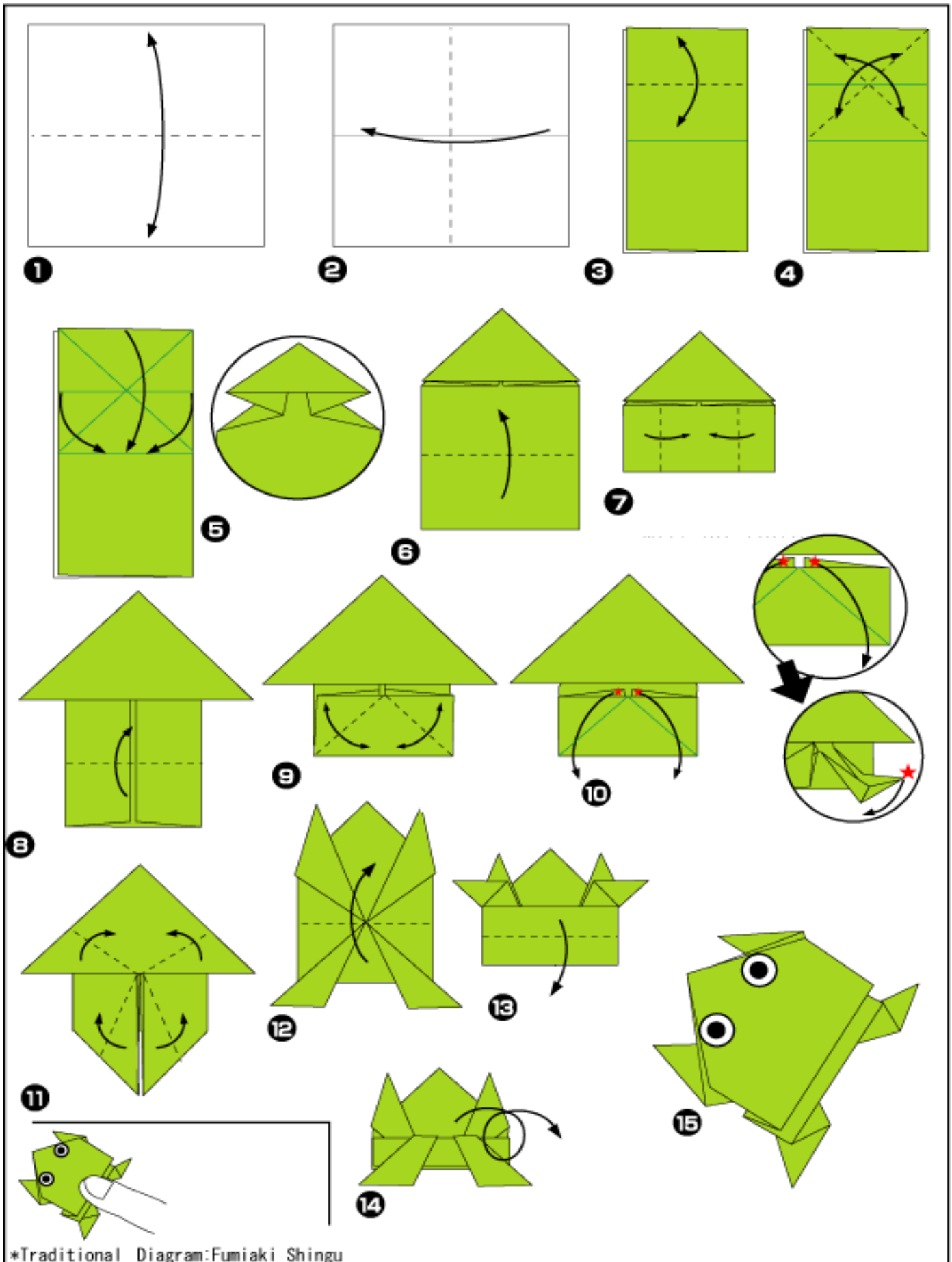

«БАБОЧКА»

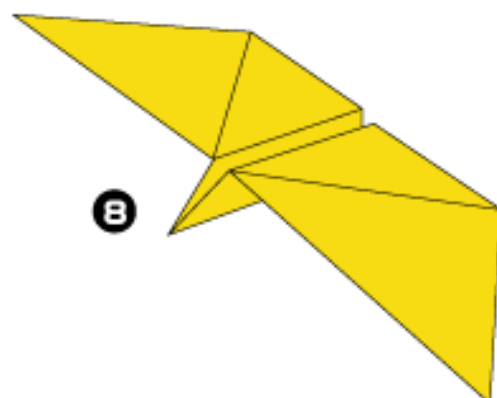
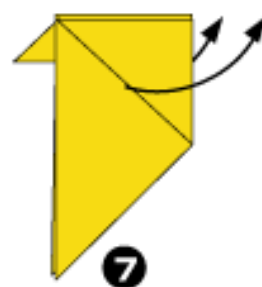
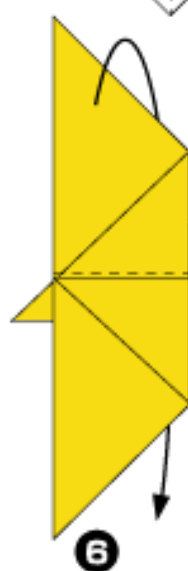
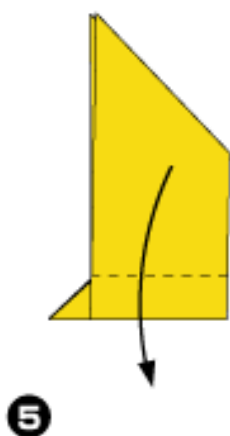
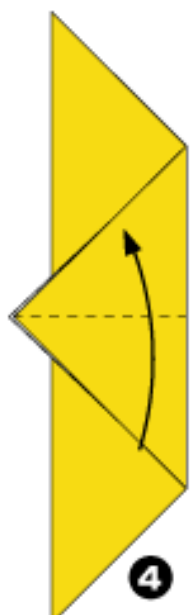
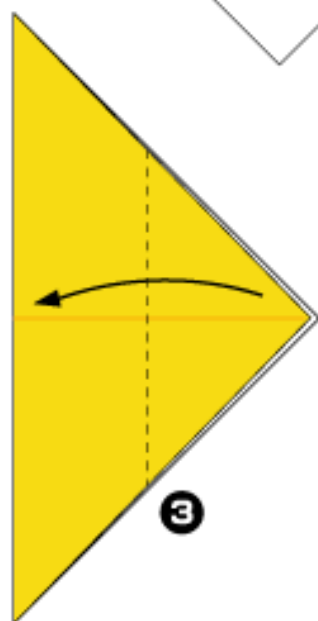
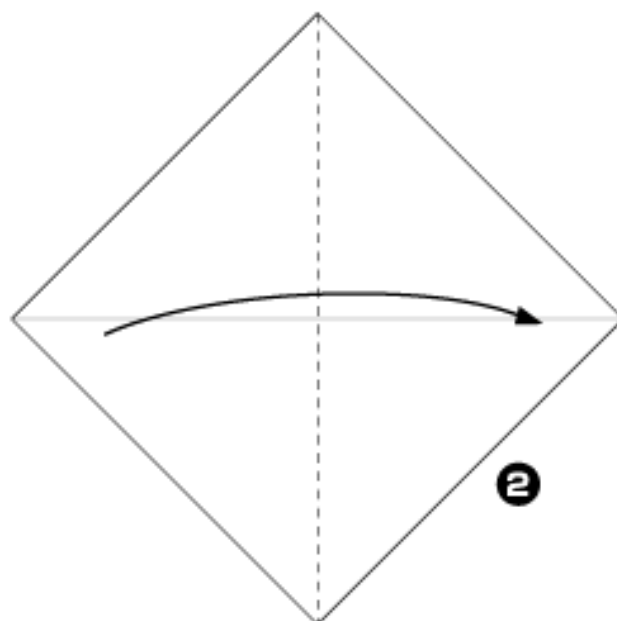
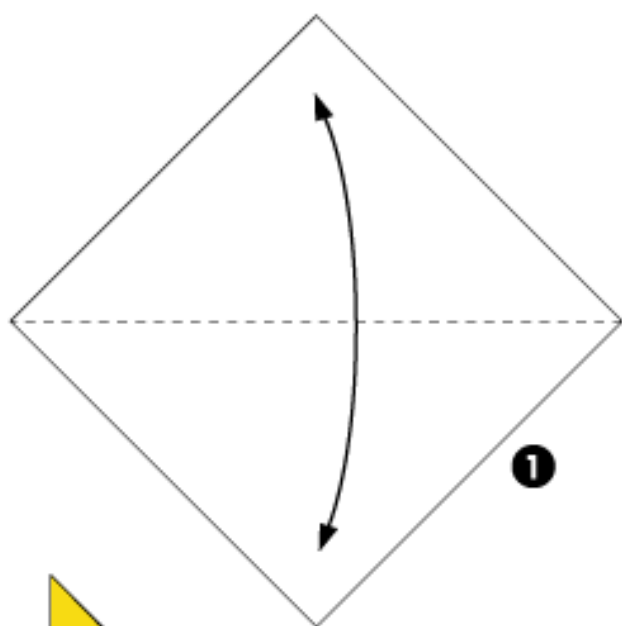

*Traditional
Diagram: Fumiaki Shingu

«СЕРДЦЕ»

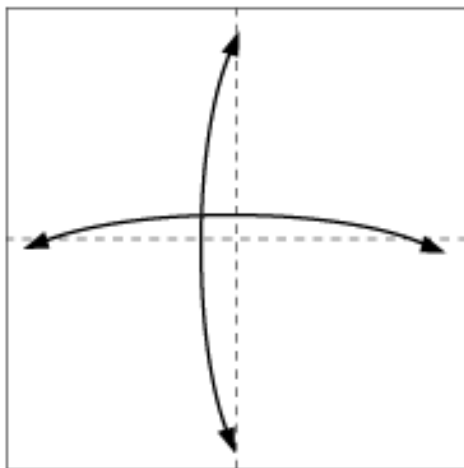

1

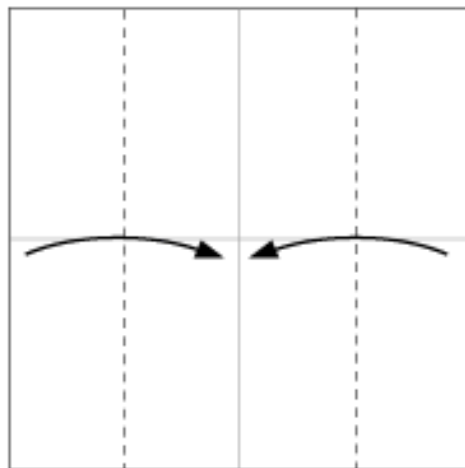

2

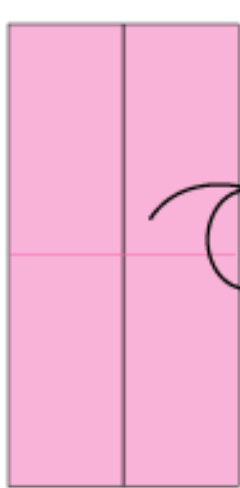

3



4



5

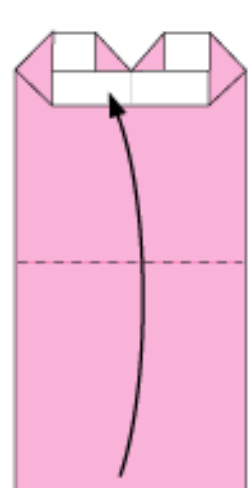

6

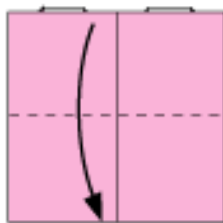

7

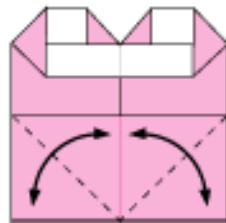

8

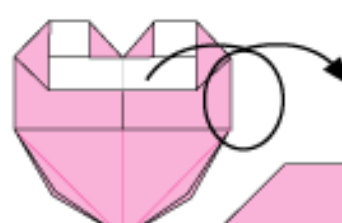

9

10

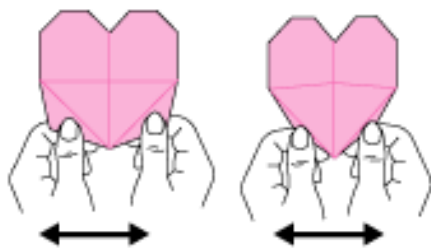

*Copyright: Fumiaki Shingu

«ПАРУСНИК»

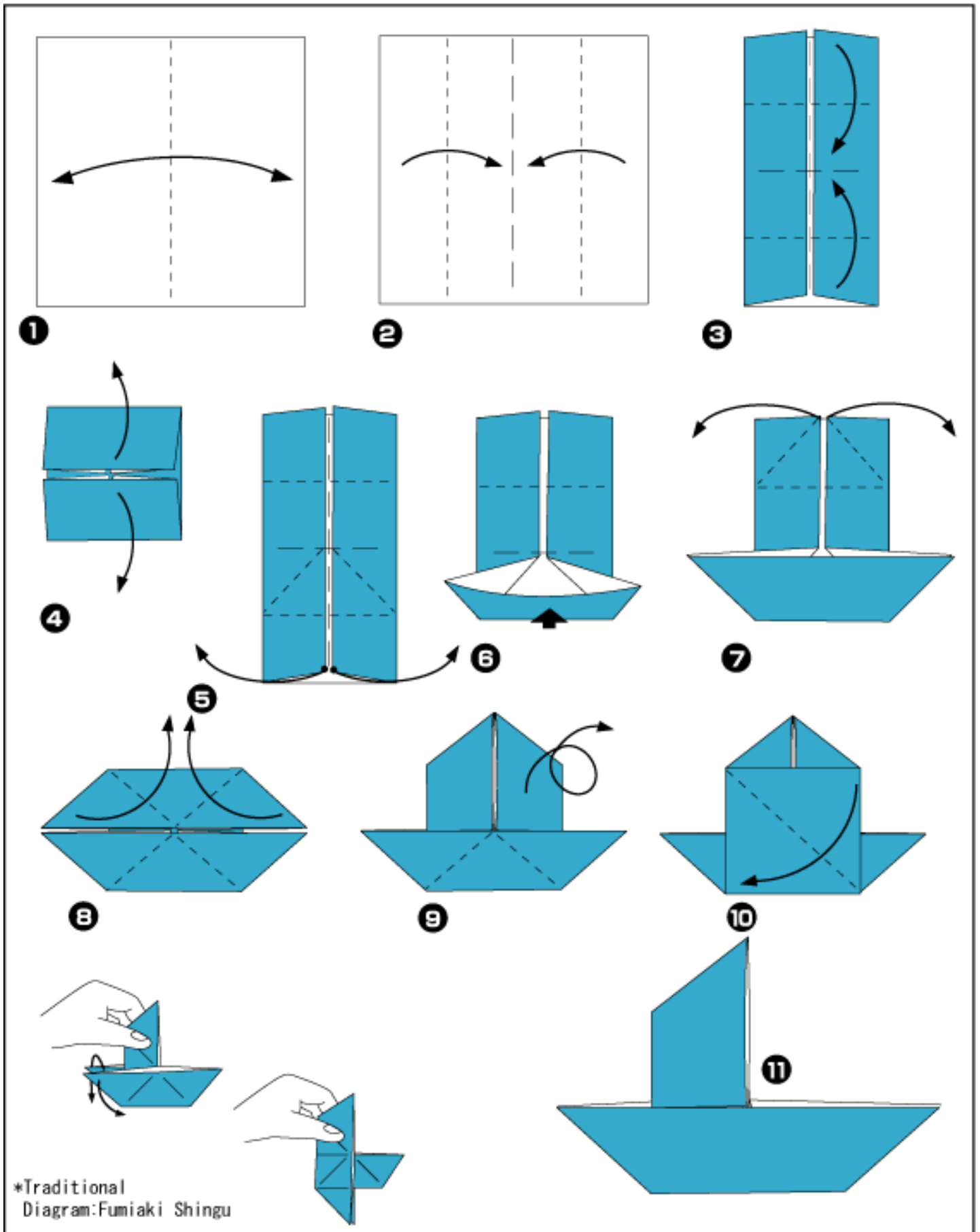

«ВЕТРЯНАЯ МЕЛЬНИЦА»

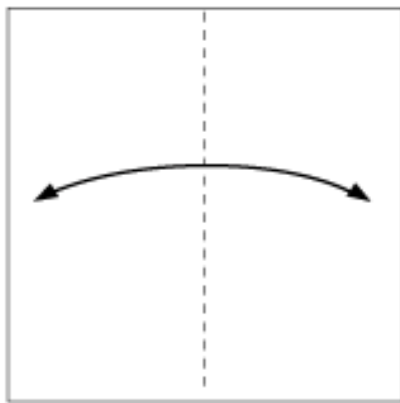

1

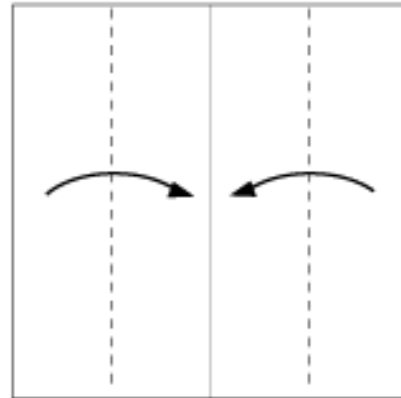

2

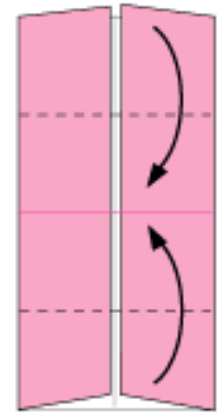

3

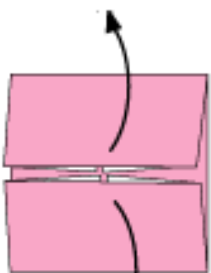

4

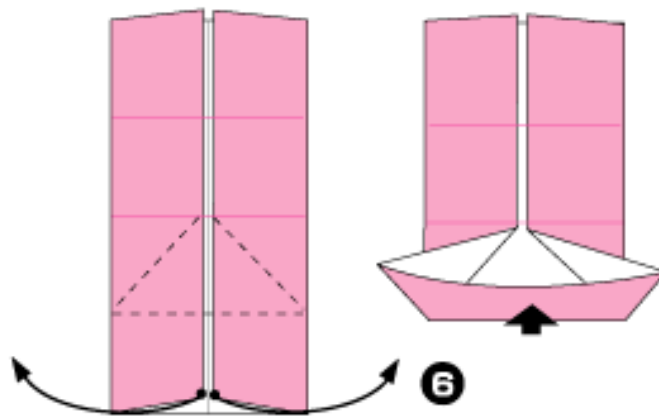

5

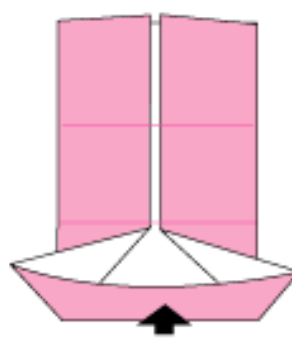

6

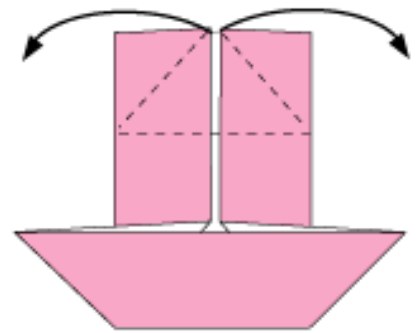

7

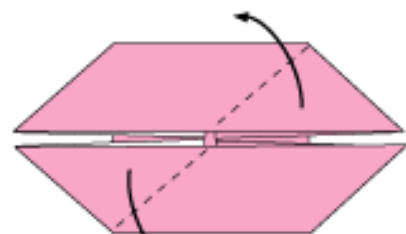

8

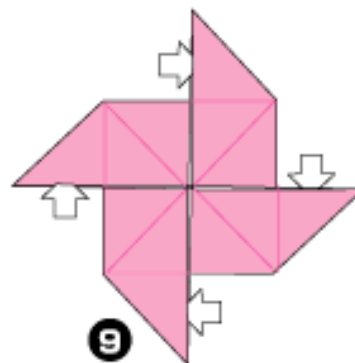

9

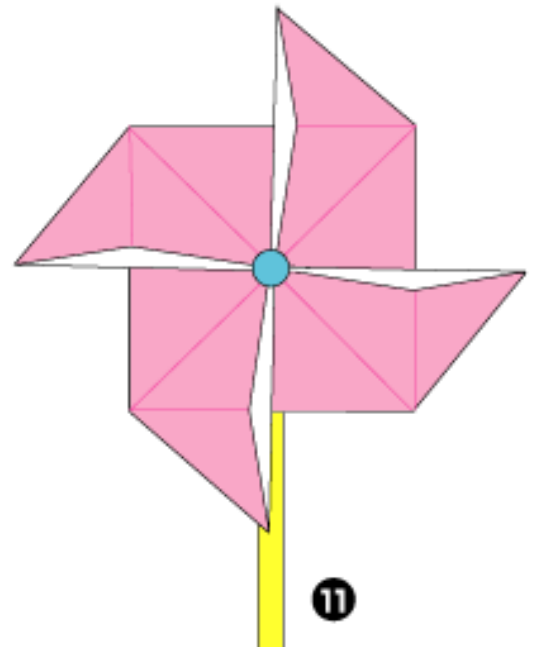

10

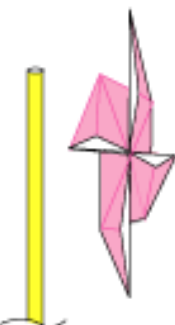

11

*Traditional Diagram:Fumiaki Shingu

«ЗВЕЗДА»

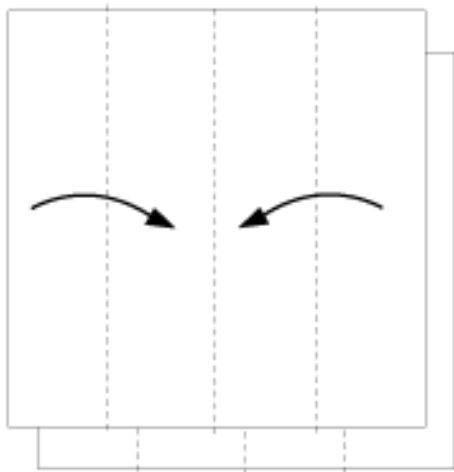

1

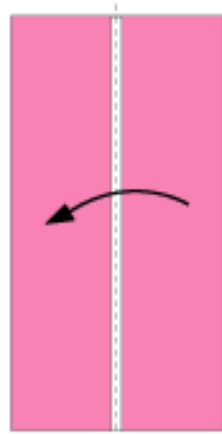

2



3

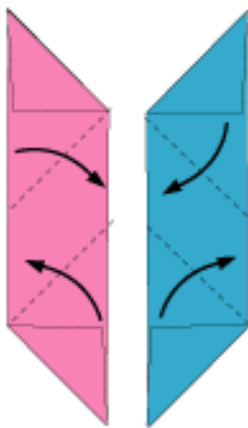
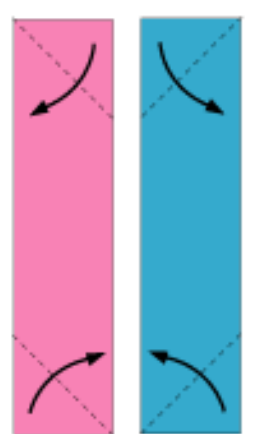

4

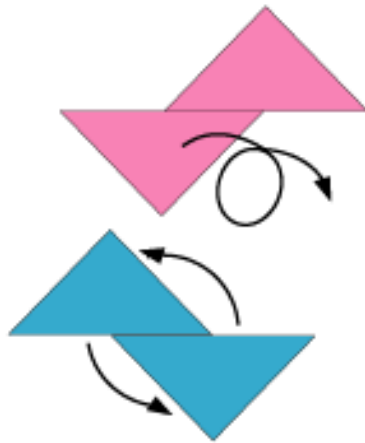

5

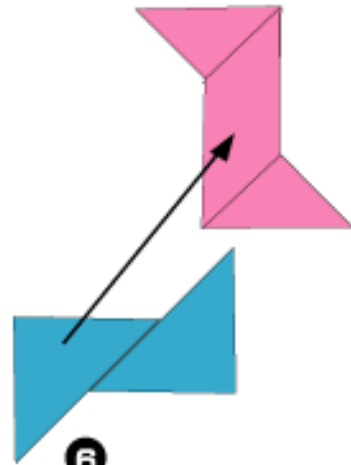

6

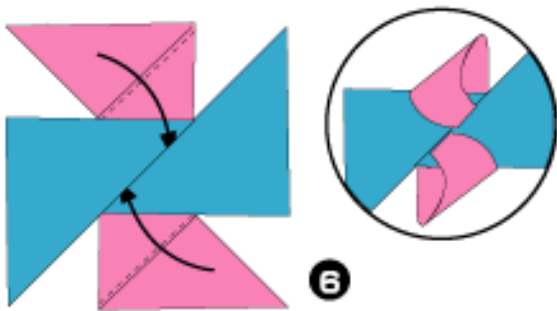

6

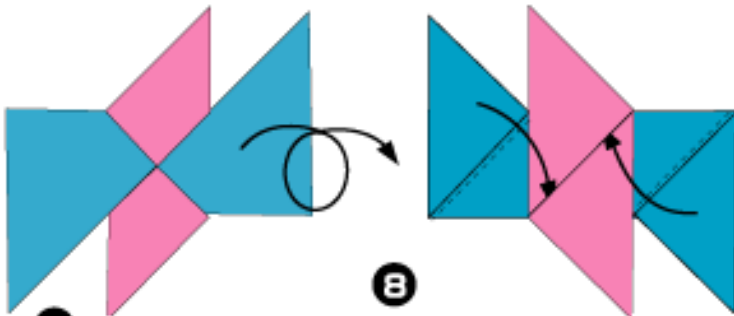

7

8



9

*Traditional
Diagram: Fumiaki Shingu

«ХОМЯК»

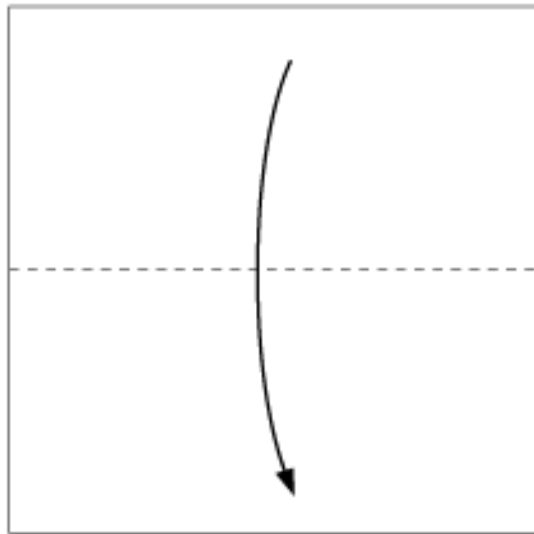

1

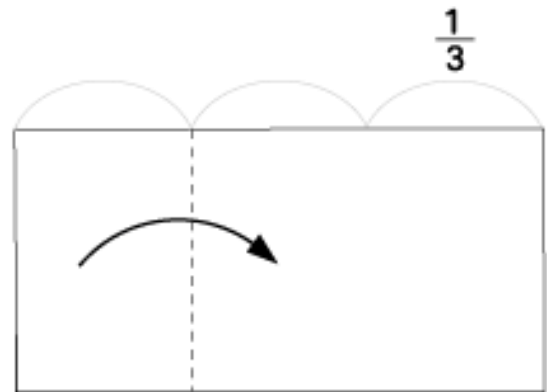

2

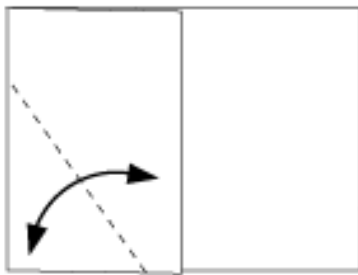

3

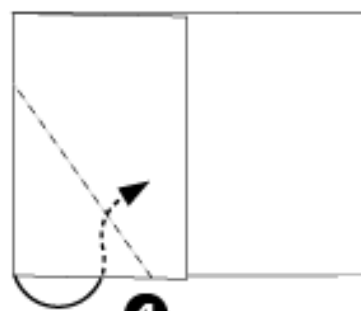

4

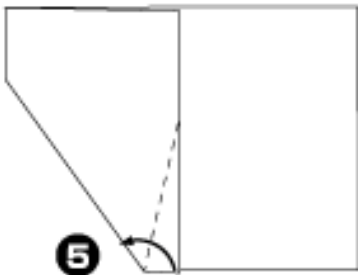

5

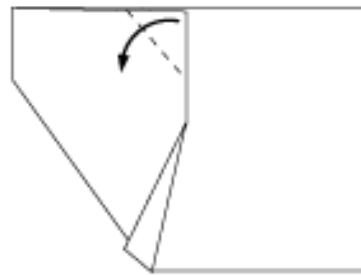

6

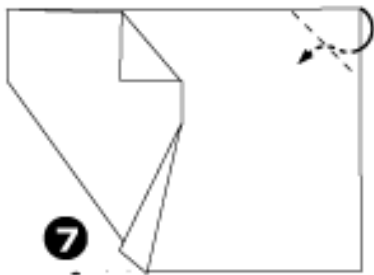

7

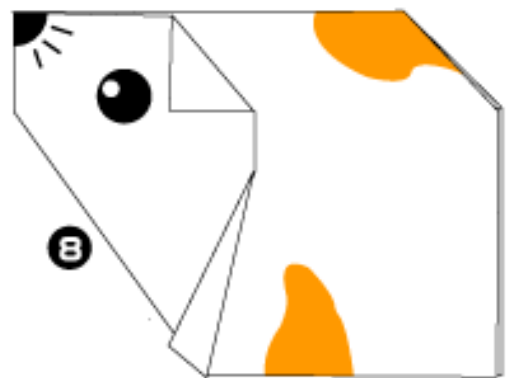

8

«УТКА»

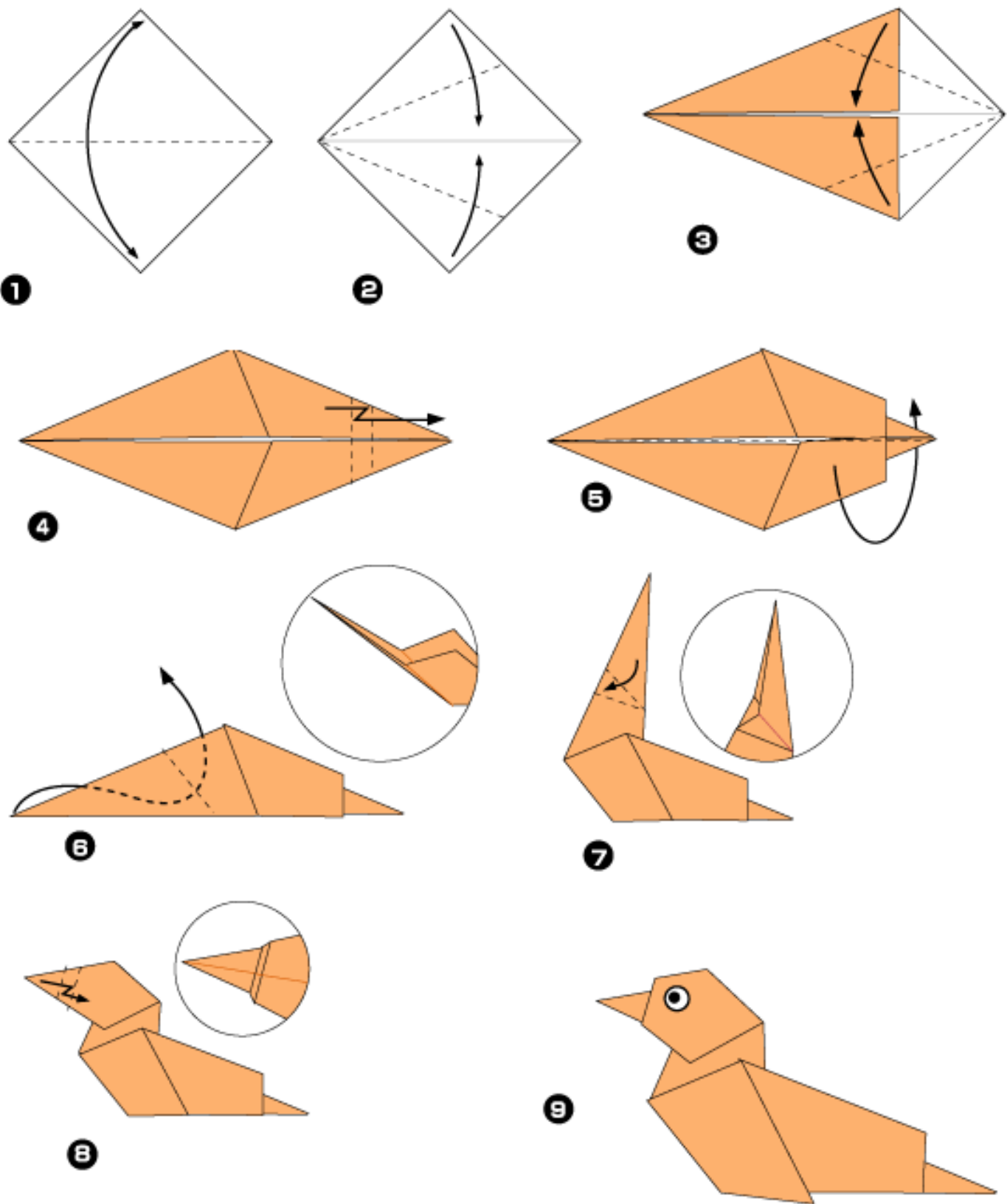

«БОРОНА»

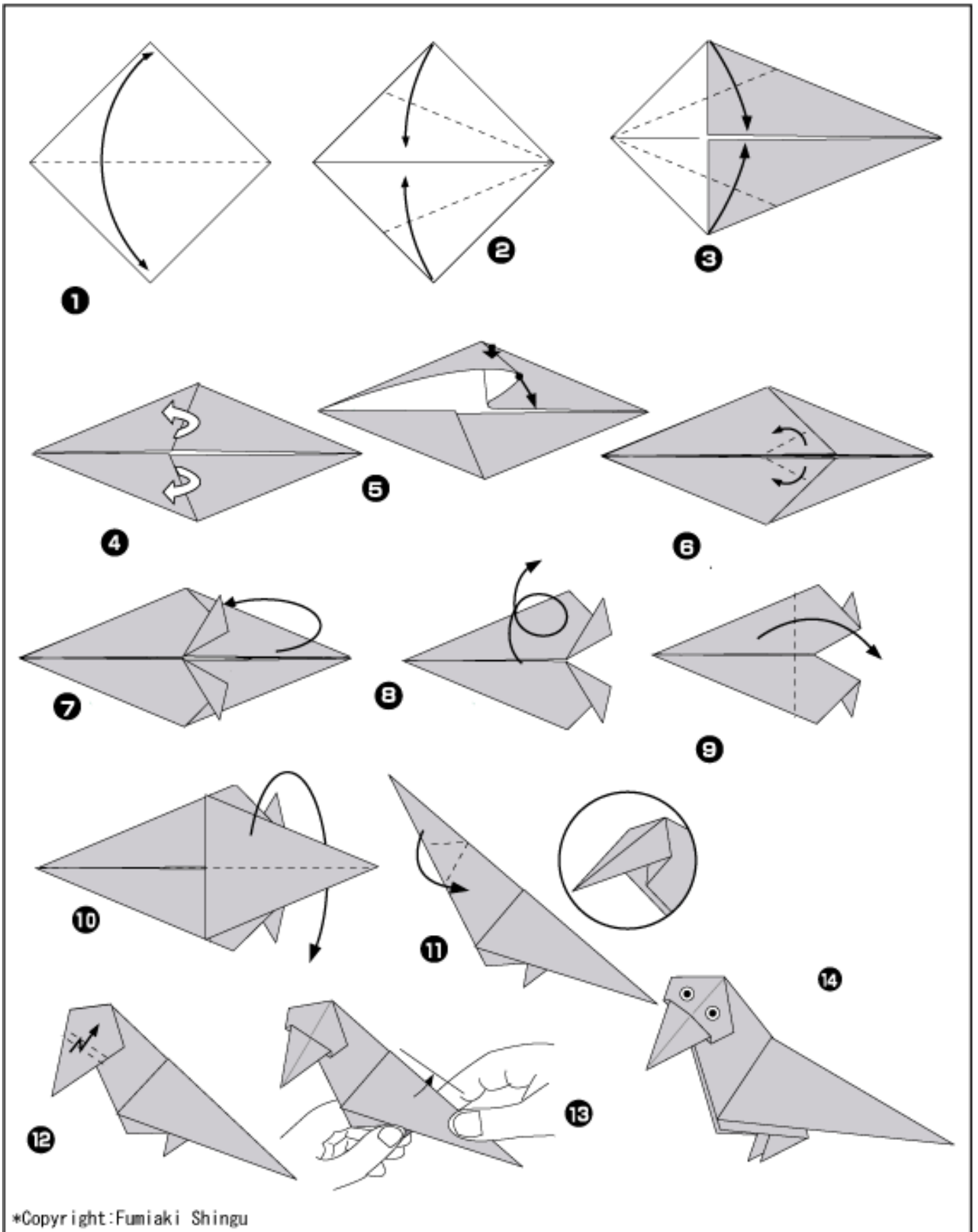

«ЗМЕЯ»

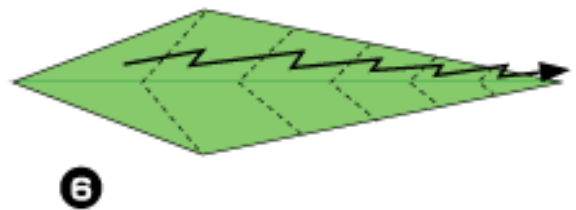
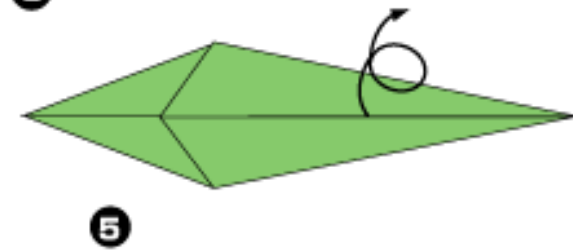
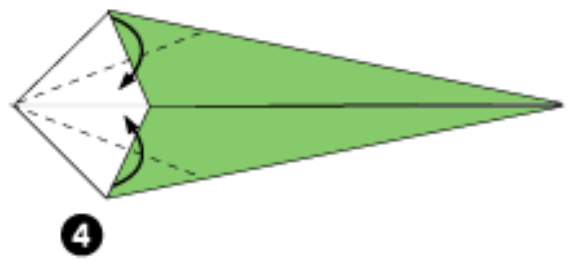
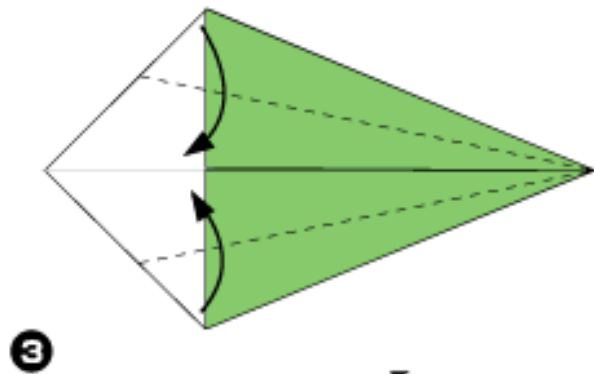
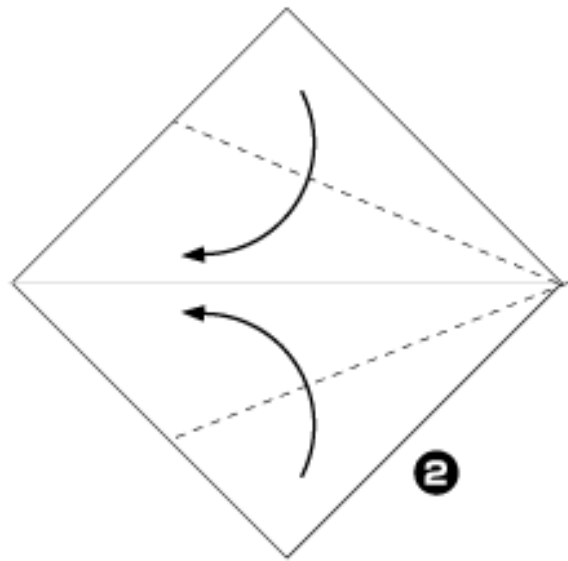
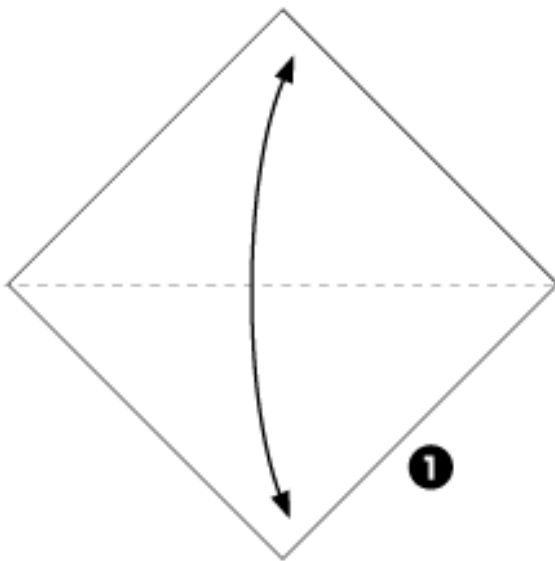

«МЫШЬ»

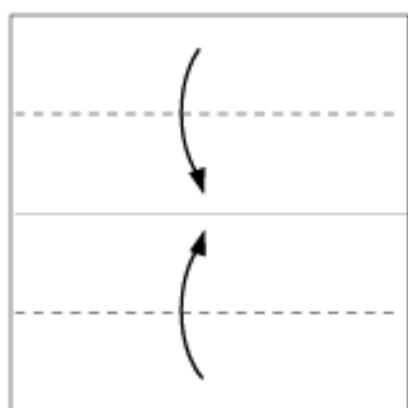

1

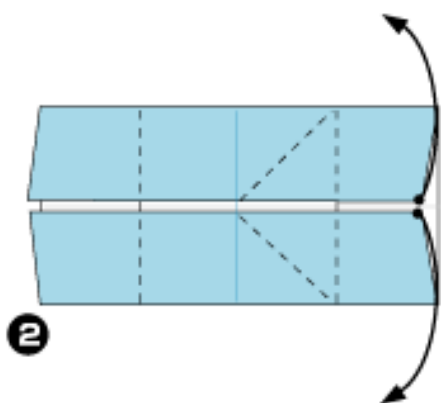

2

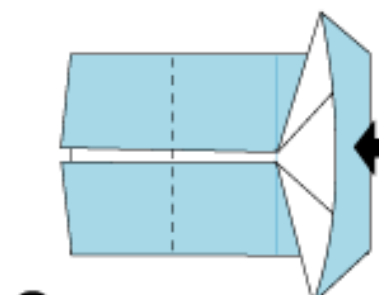

3

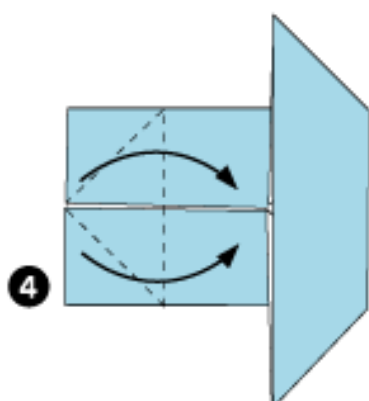

4

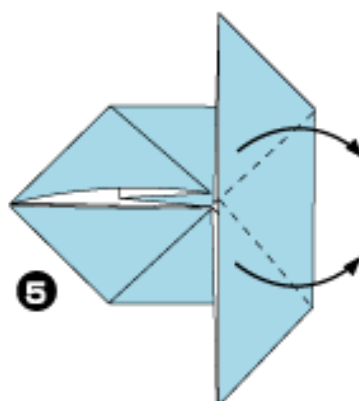

5

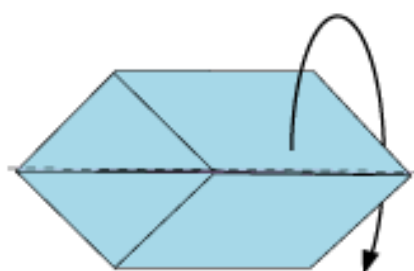

6

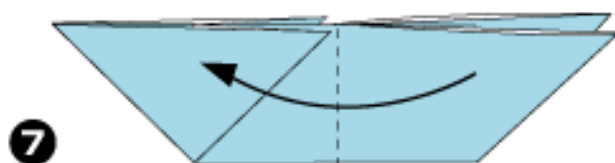

7

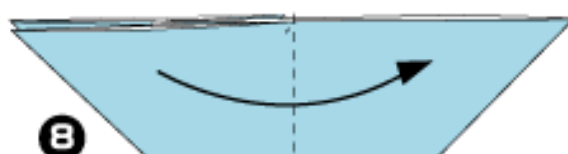

8

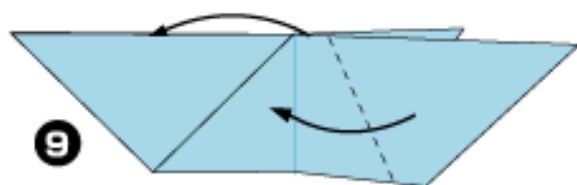

9

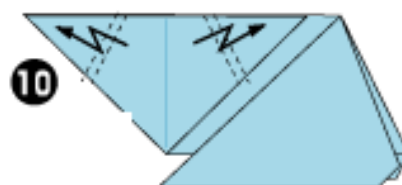

10



11



12

15

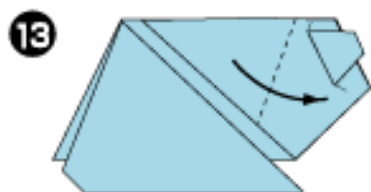

13

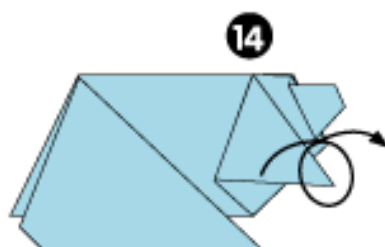

14

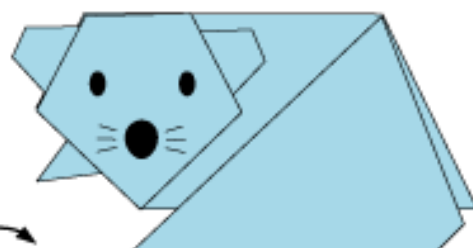

«TAKCA»

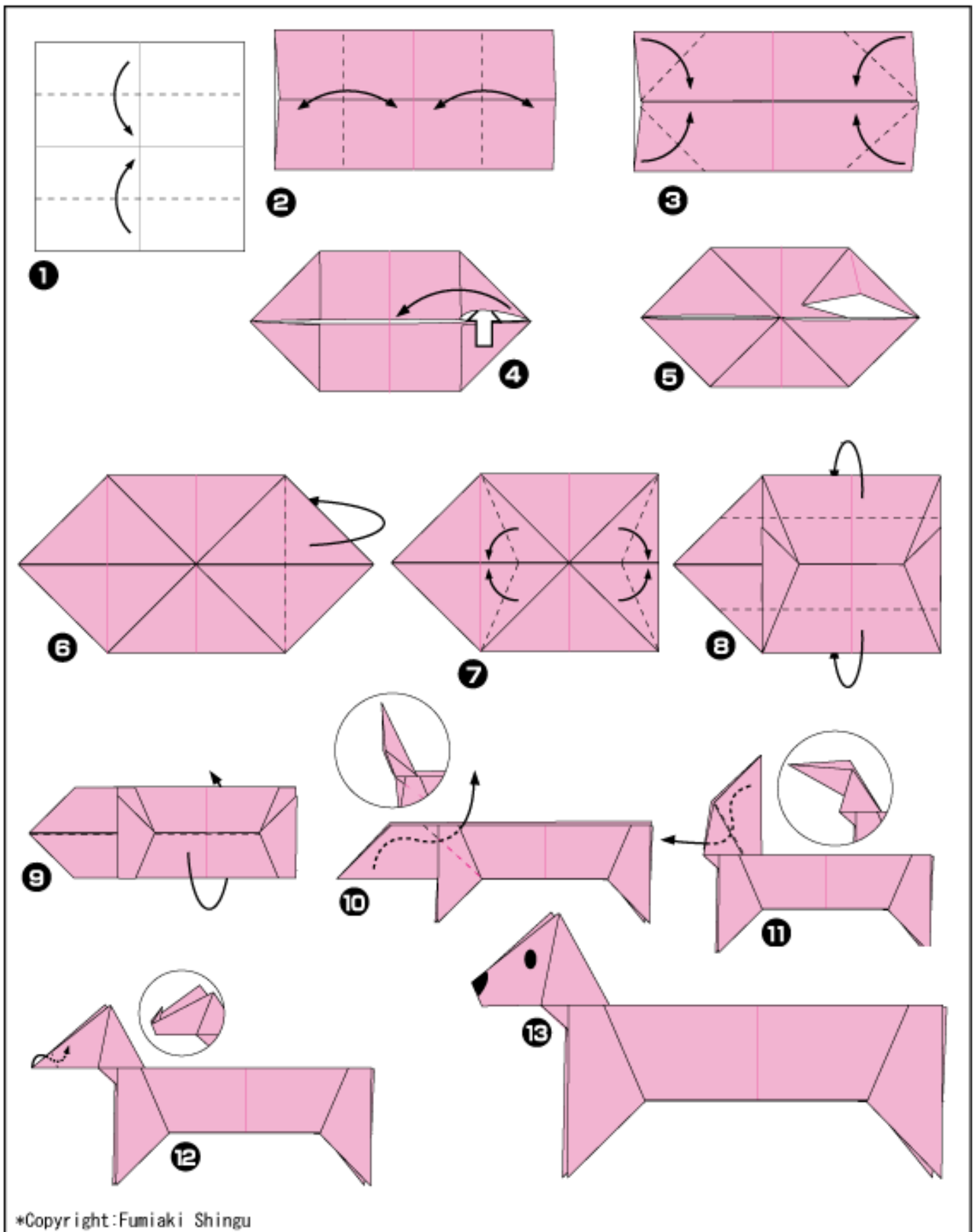

«СТРАУС»

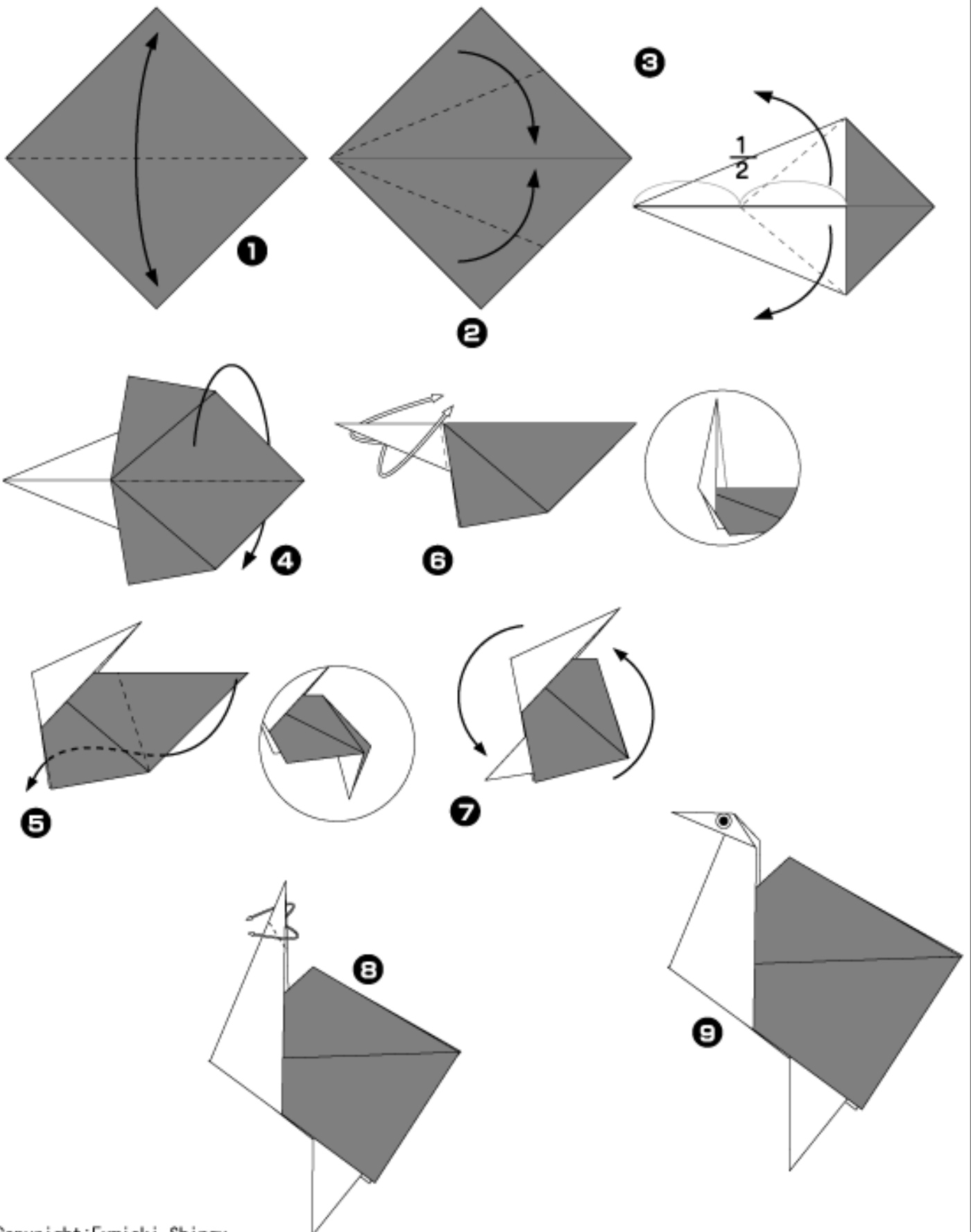

«МЫШЬ»

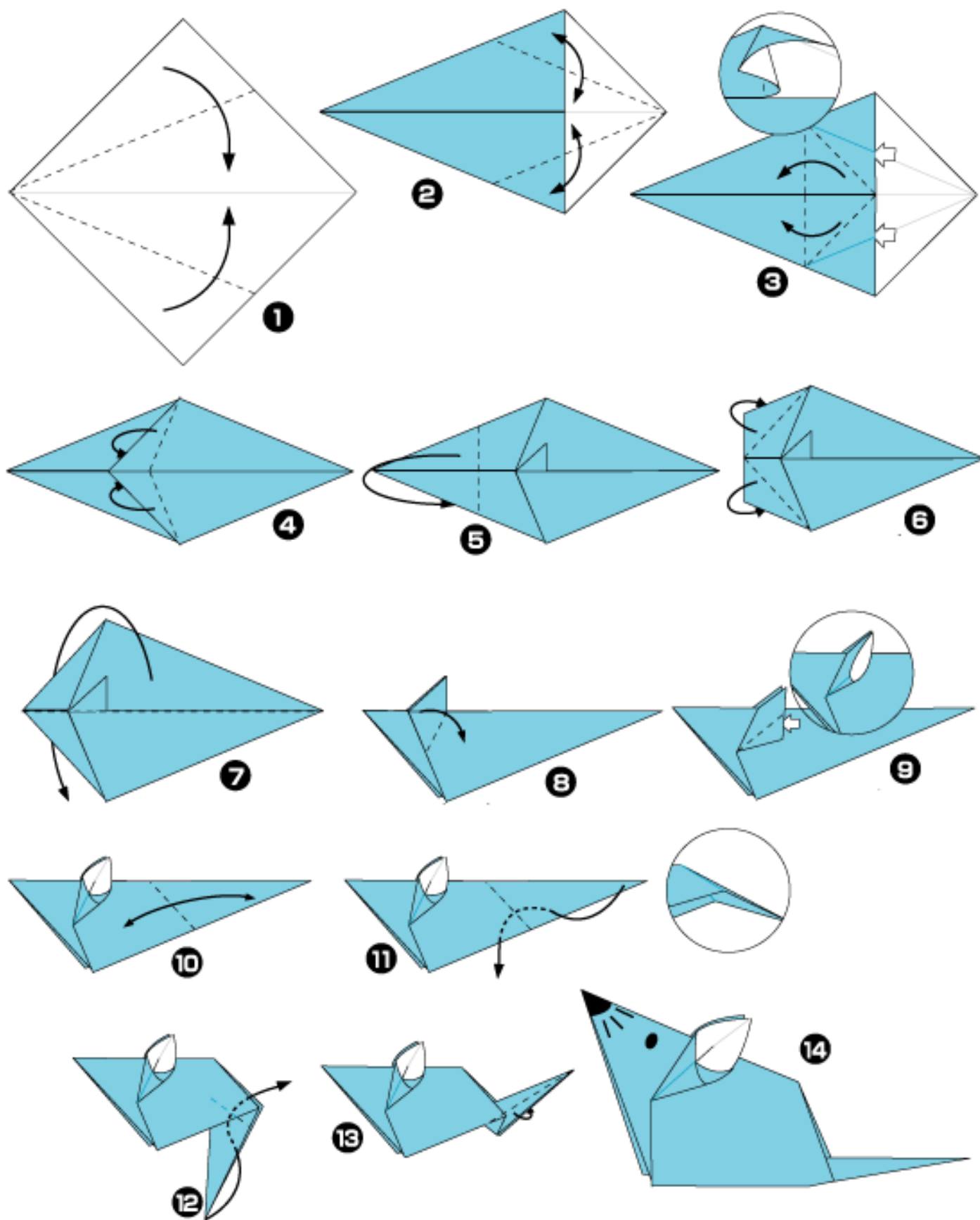

«БАНАНЫ»

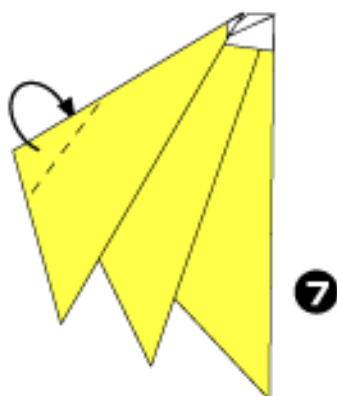
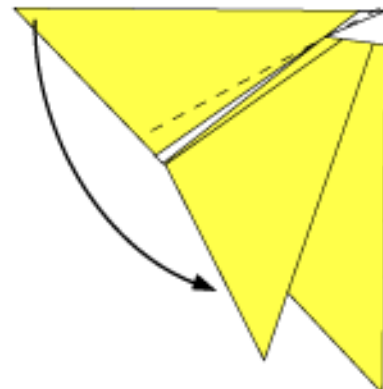
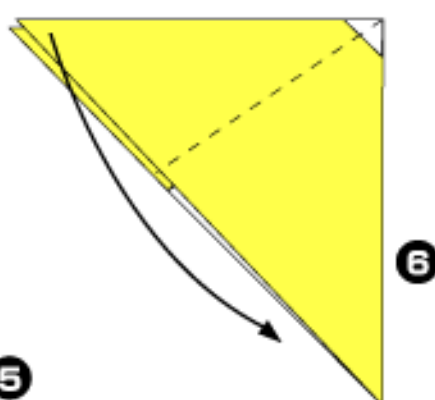
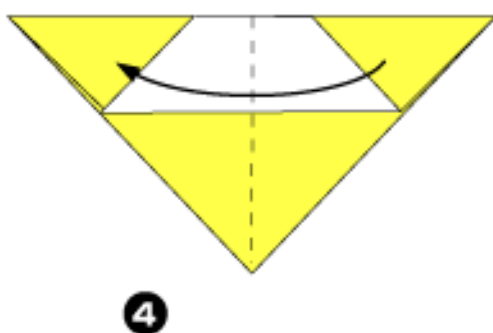
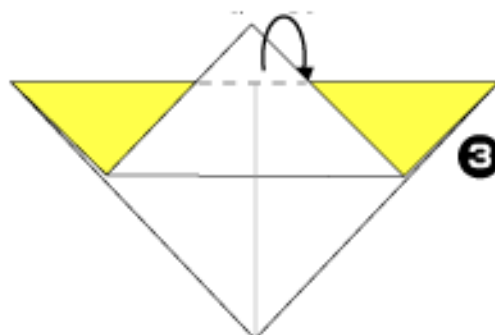
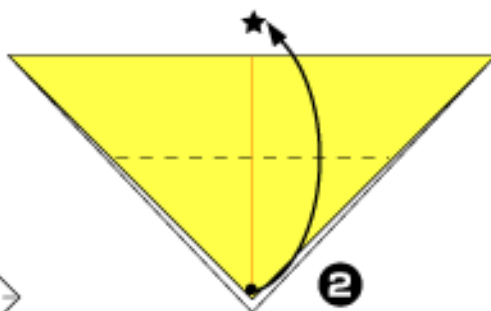
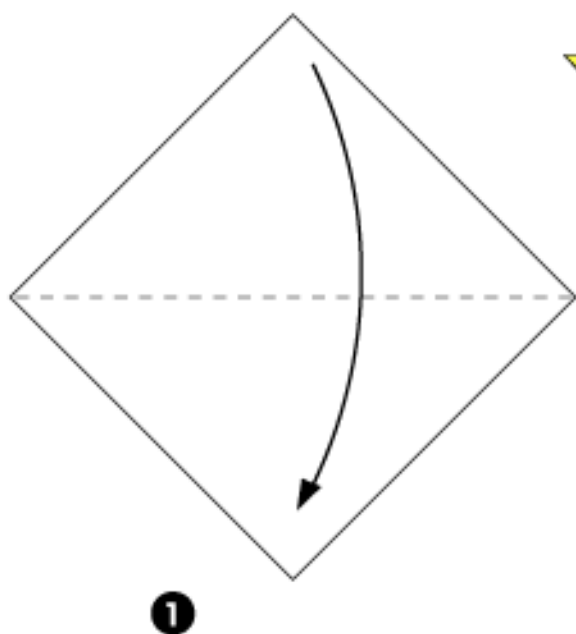

«ГРИБ»

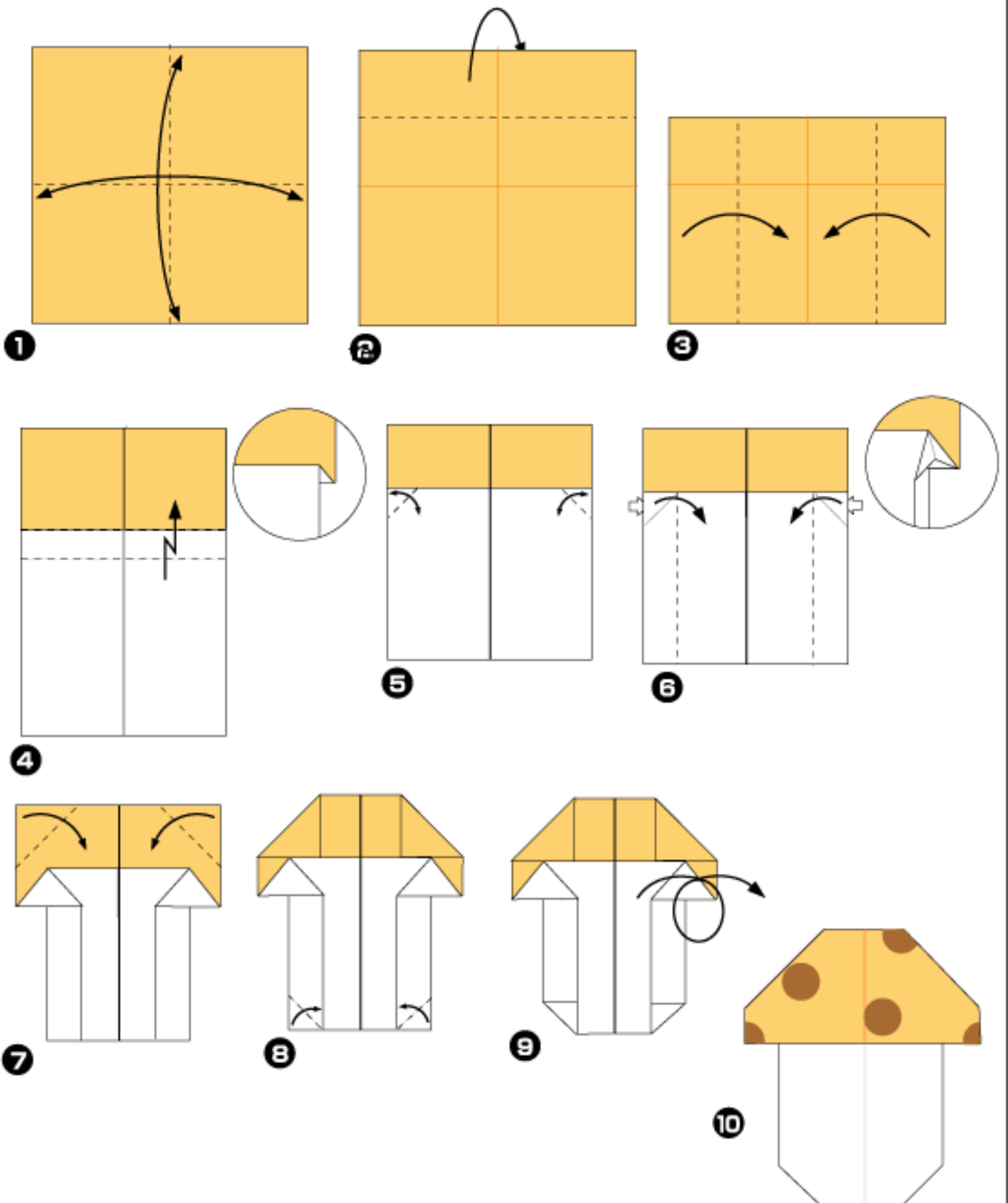

«МОРКОВЬ»

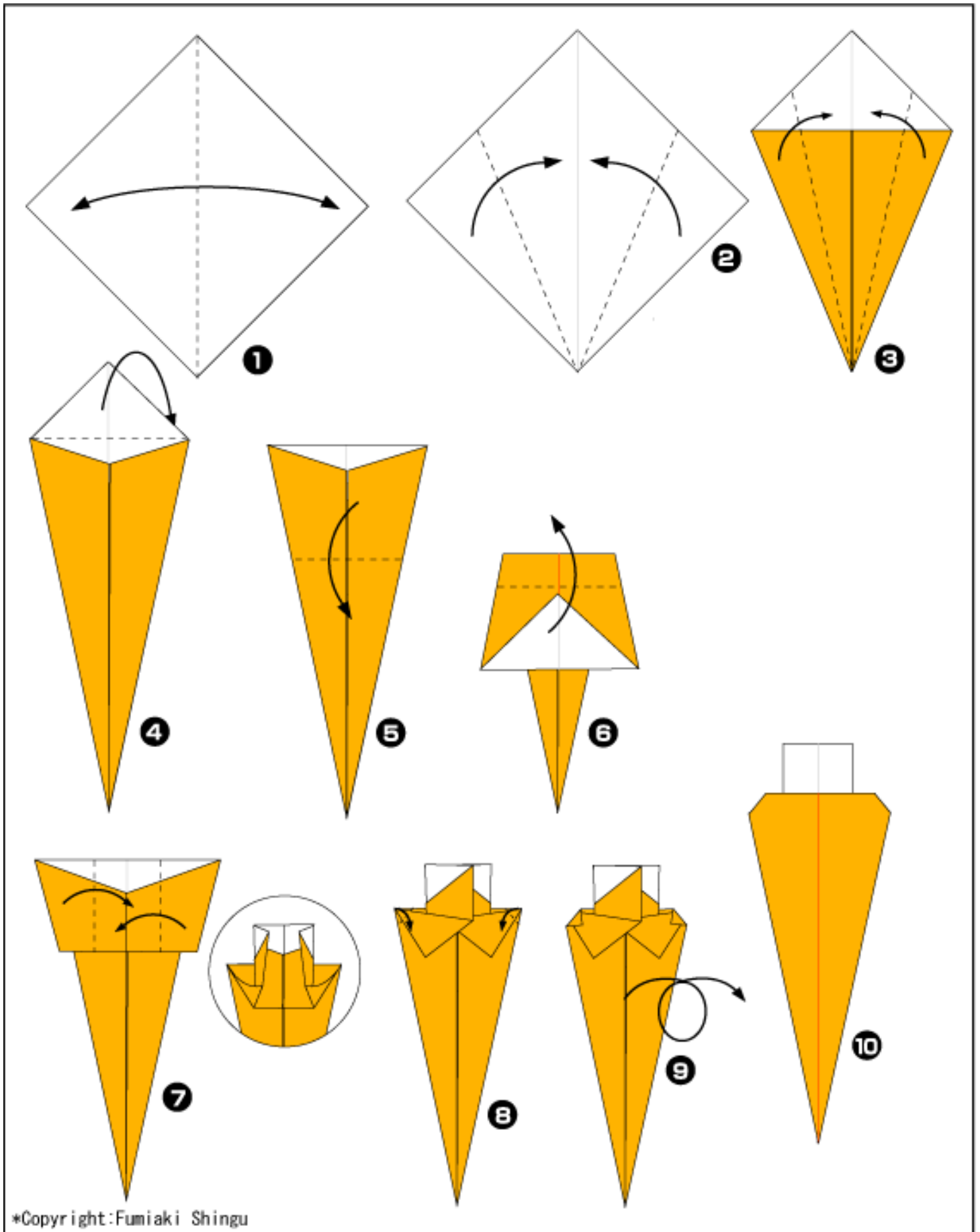

«ЯБЛОКО»

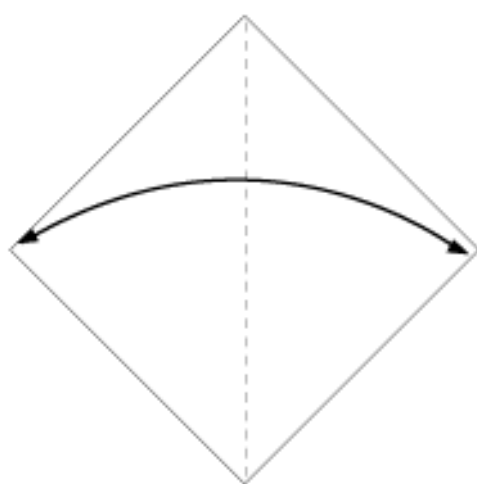

1

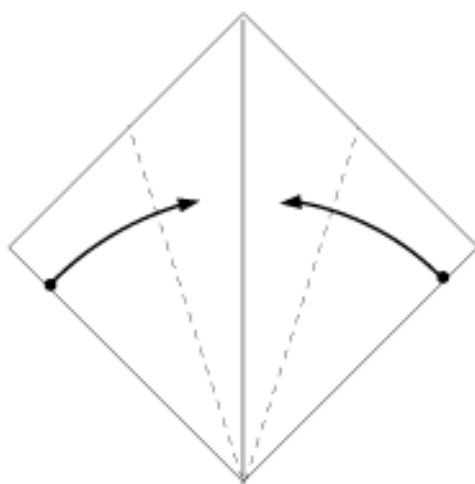

2

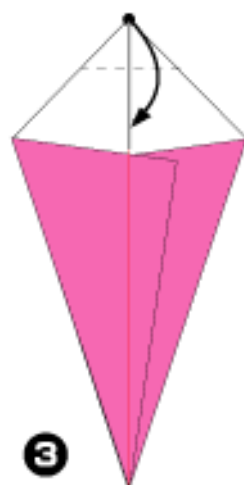

3

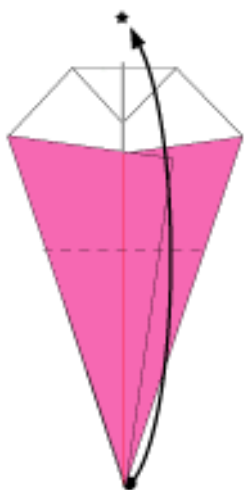

4

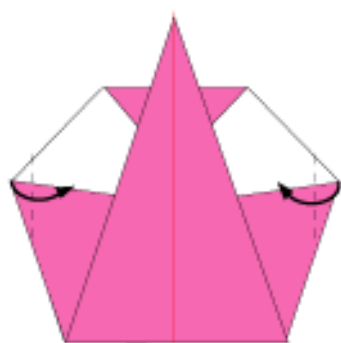

5



6



7

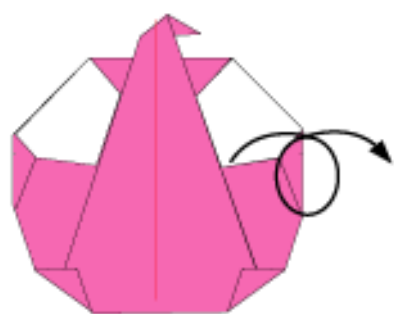

8

9 Finished

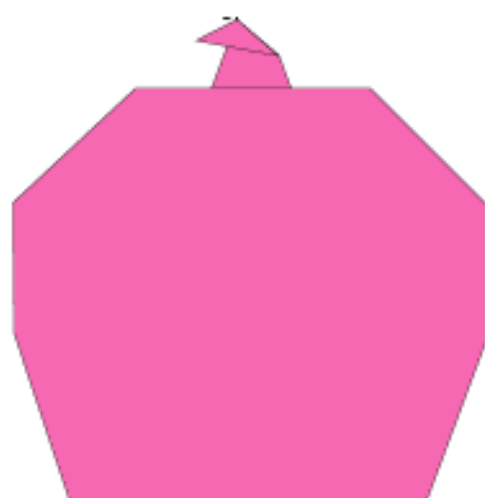

«РУБАШКА»

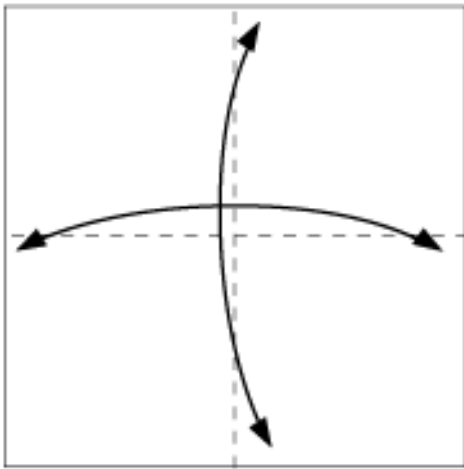

1

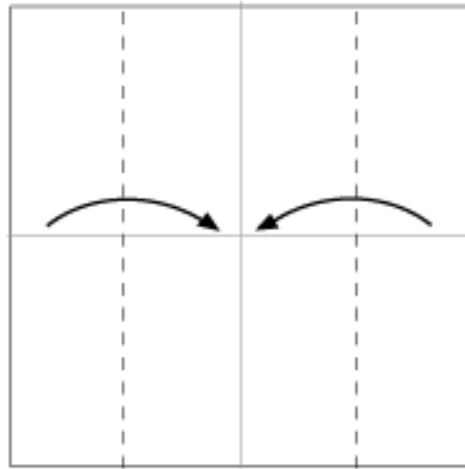

2

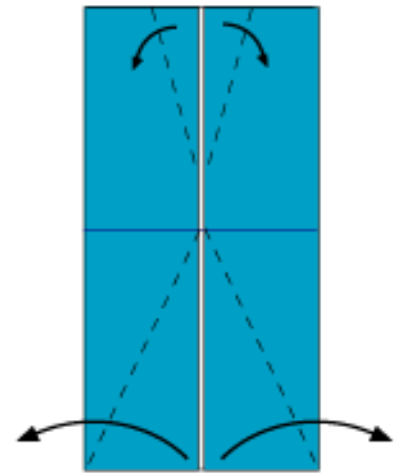

3

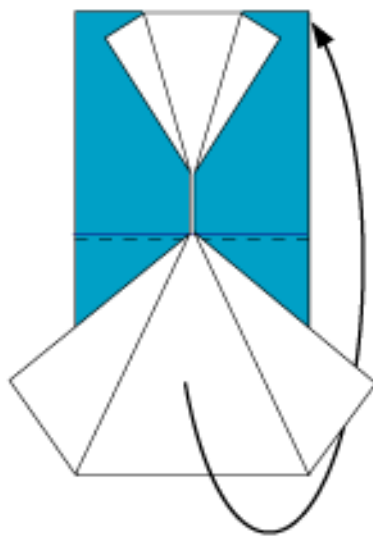

4



5



6

«ПЛАТЬЕ»

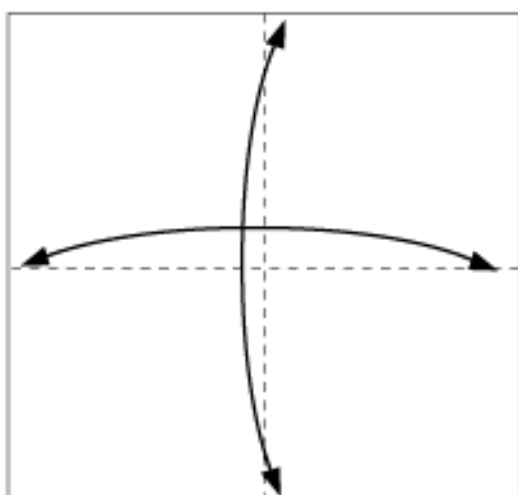

1

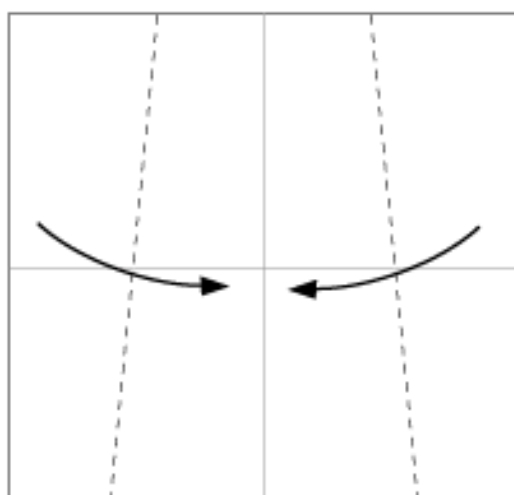

2

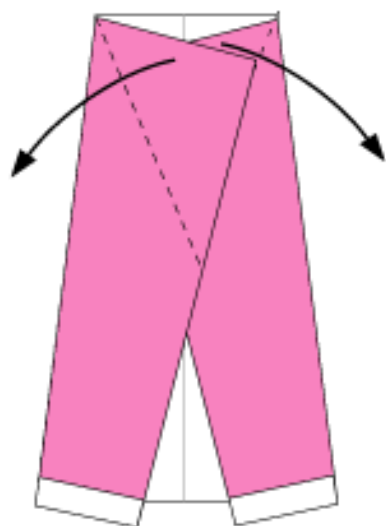

3

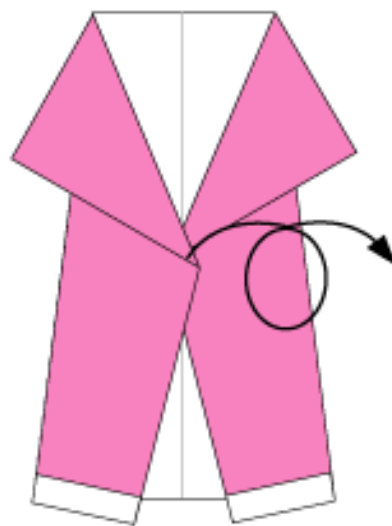

4



5



6

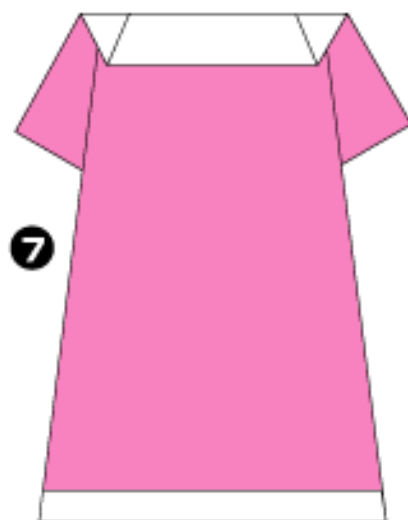

7

«ПАРТА»

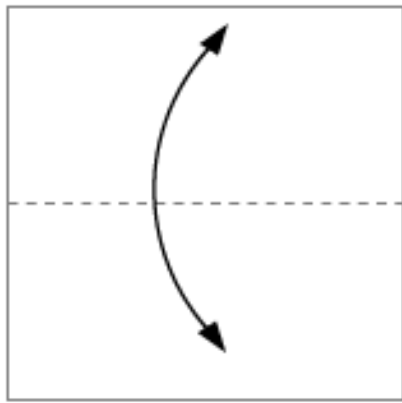

1

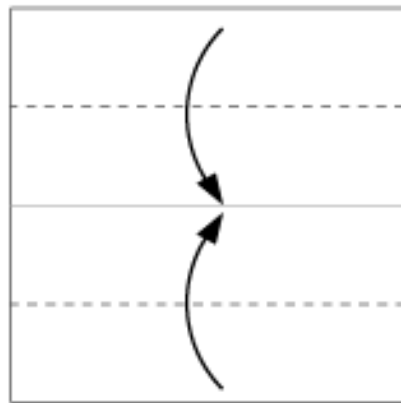

2

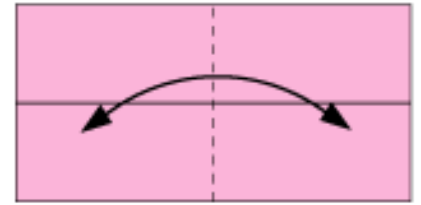

3

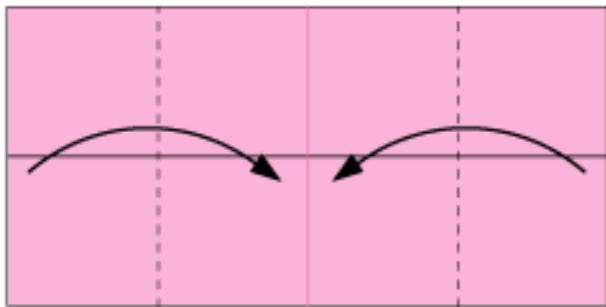

4

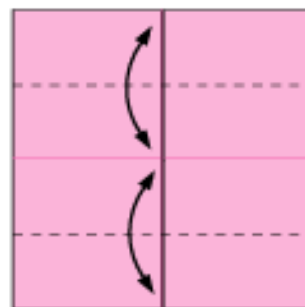

5

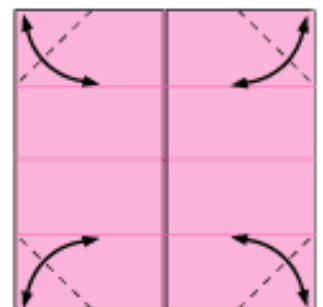

6

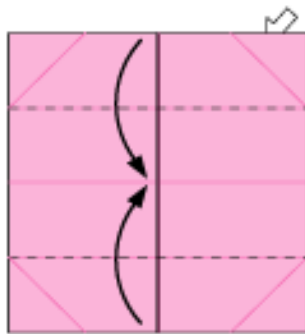

7

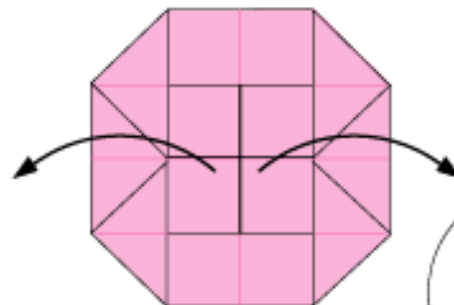

8

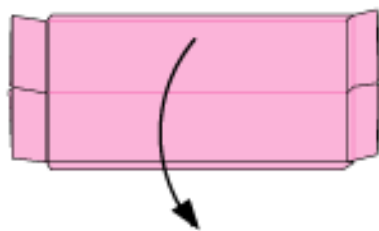

9

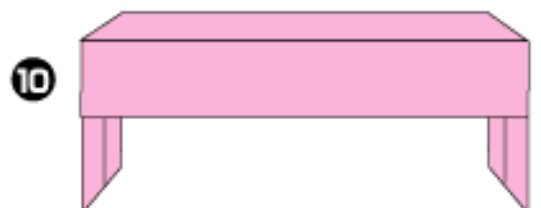

10

«СТОЛ»

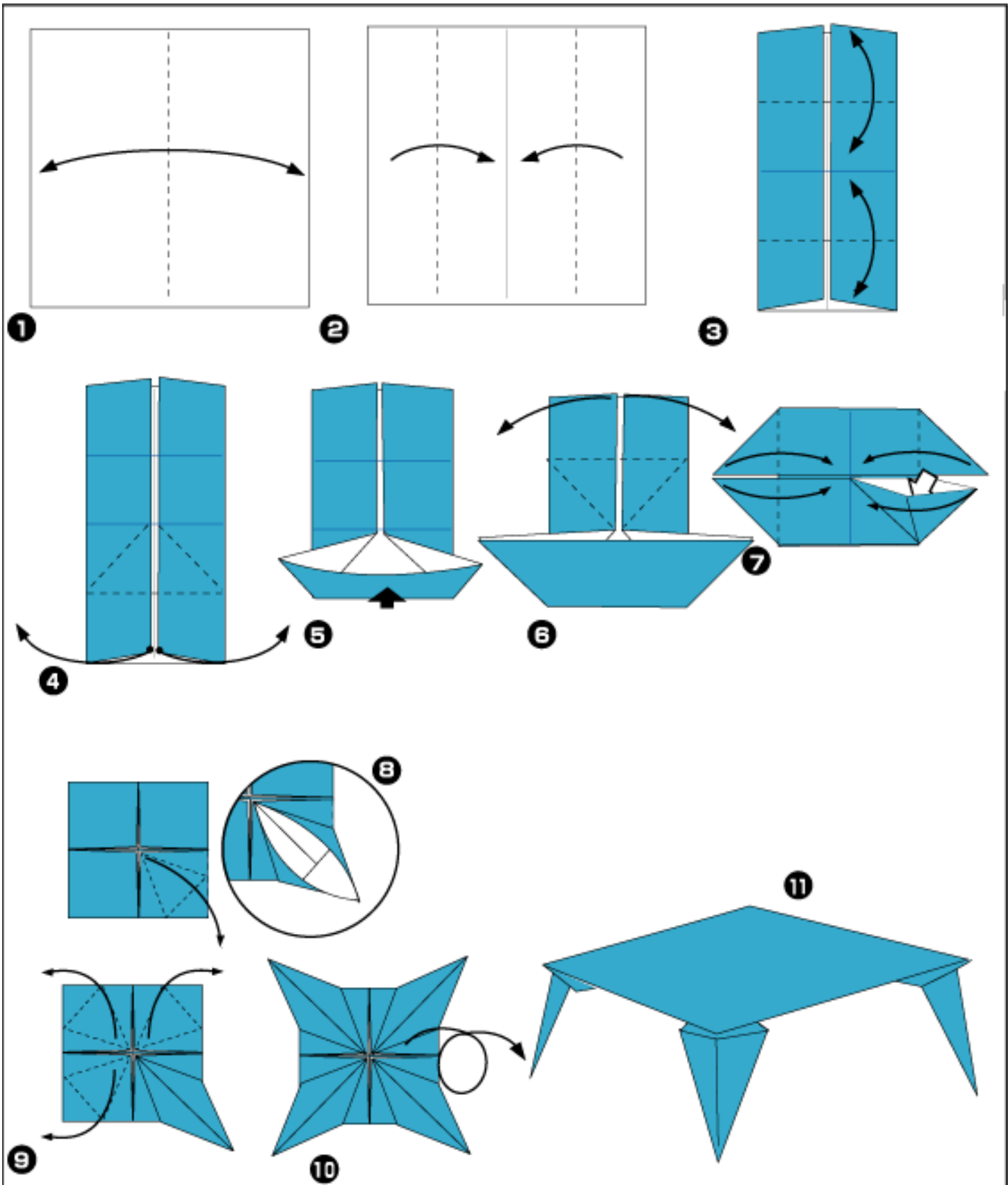

*Traditional
Diagram: Fumiaki Shingu

«ДОМ»

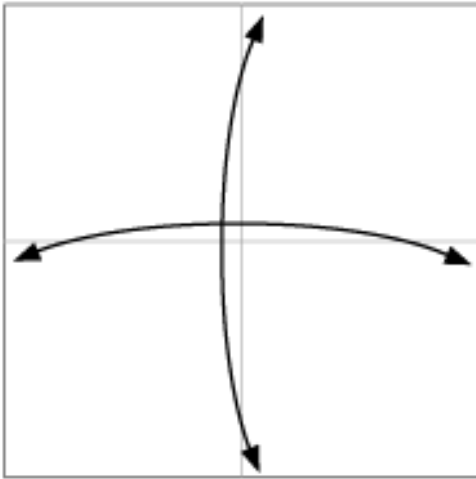

1

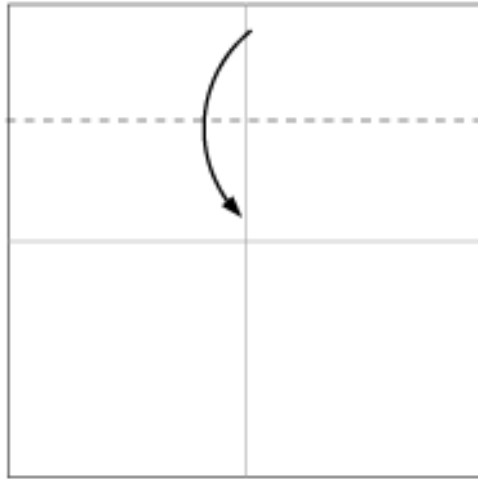

2

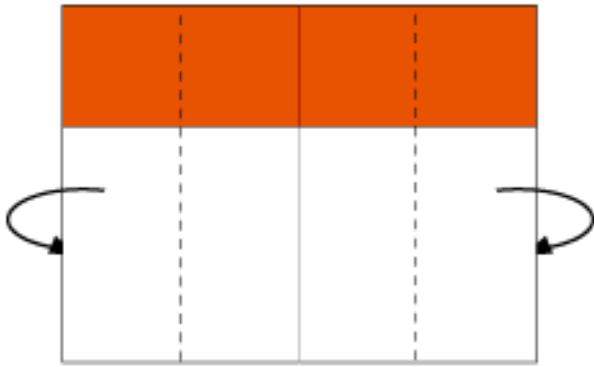

3

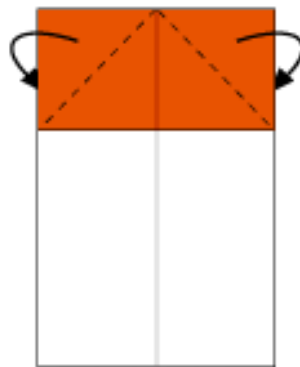

4

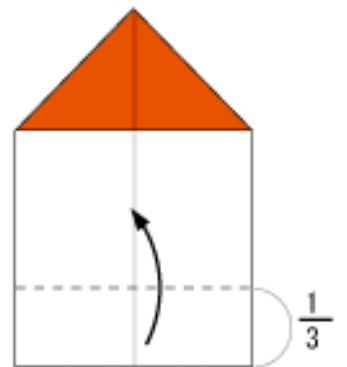

5

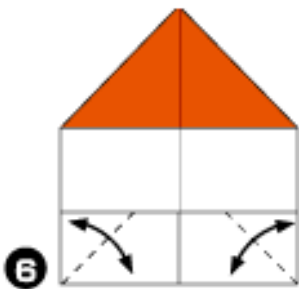

6

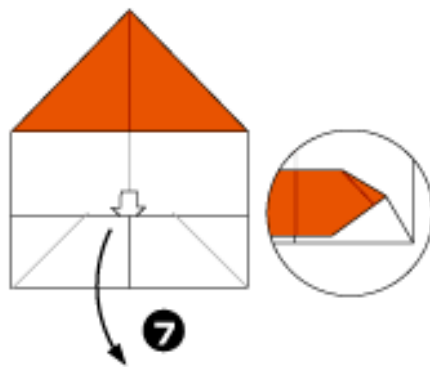

7

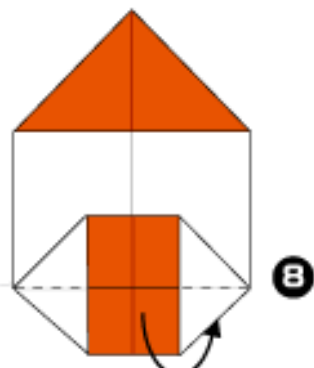

8

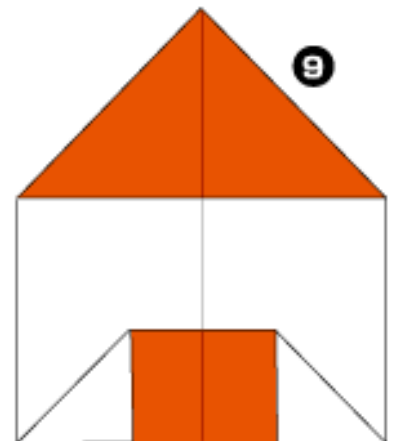

9

«ШАПКА»

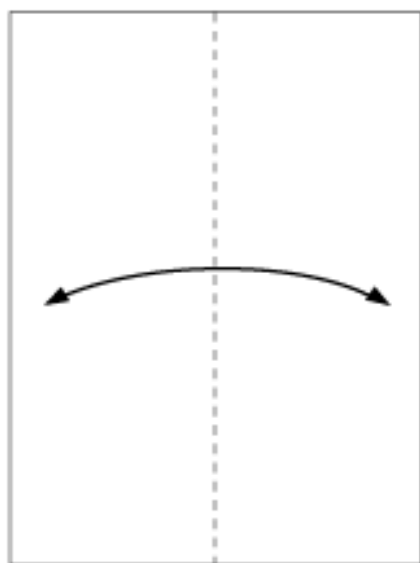

1

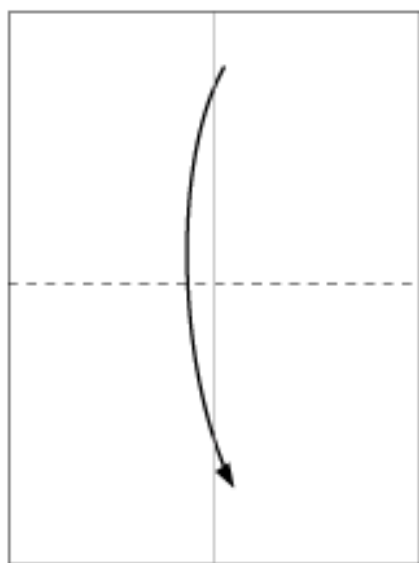

2

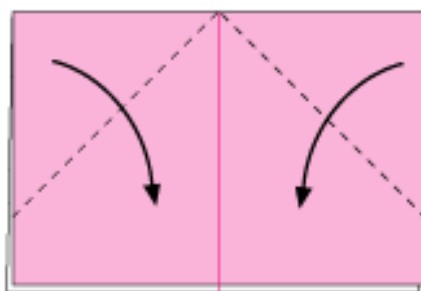

3

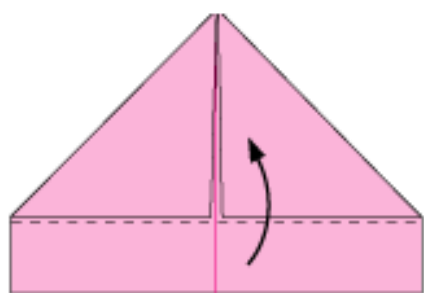

4

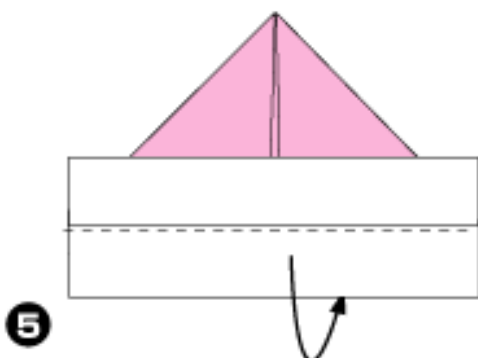

5

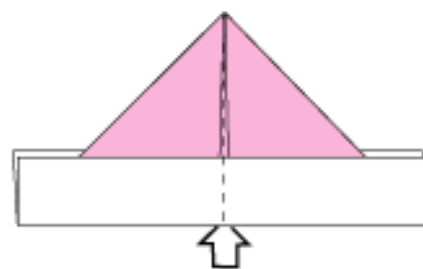

6

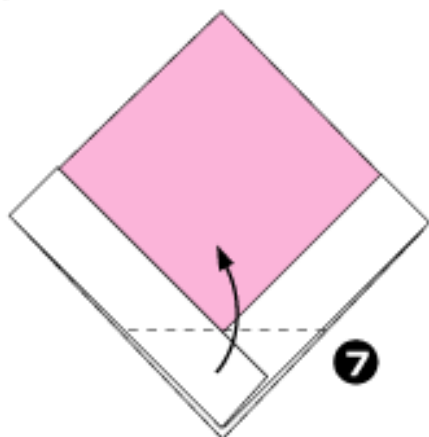

7

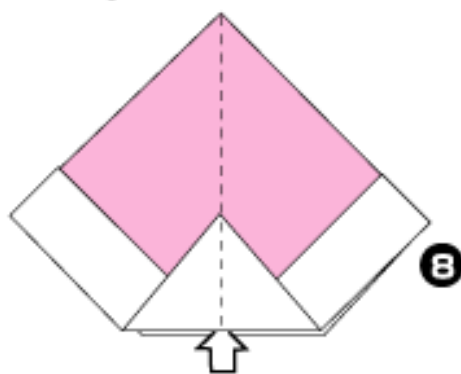

8

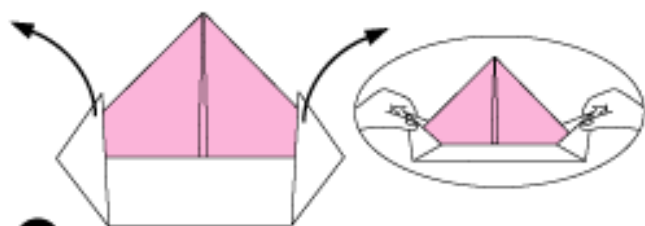

9

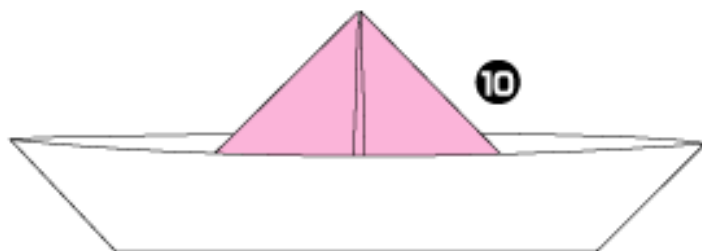

10

*Traditional
Diagram: Fumiaki Shingu

«ТАПКИ»

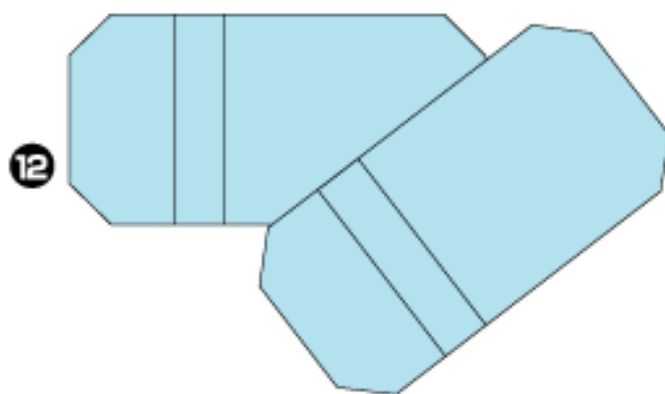
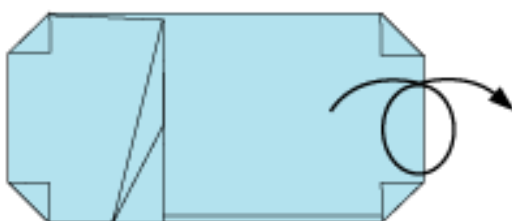
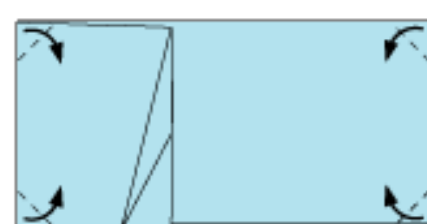
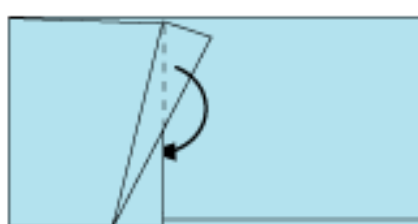
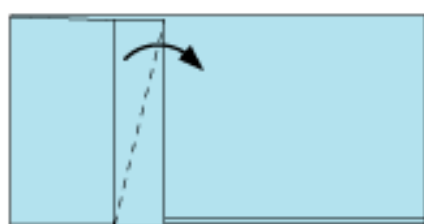
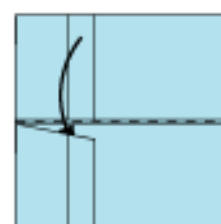
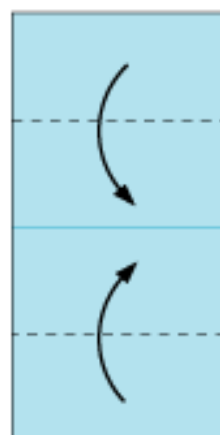
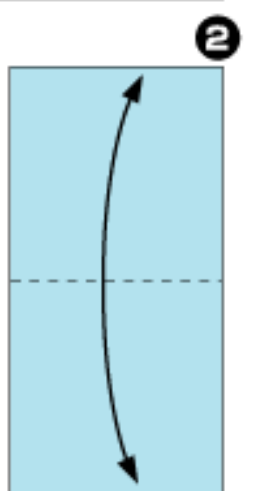
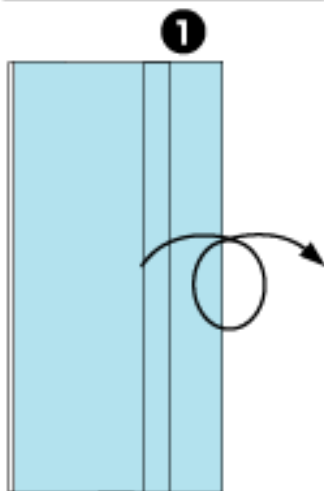
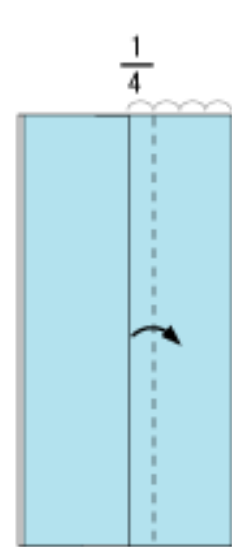
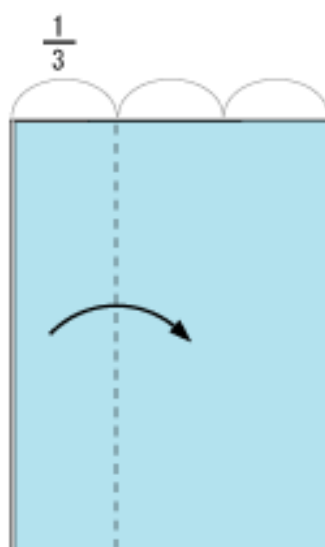
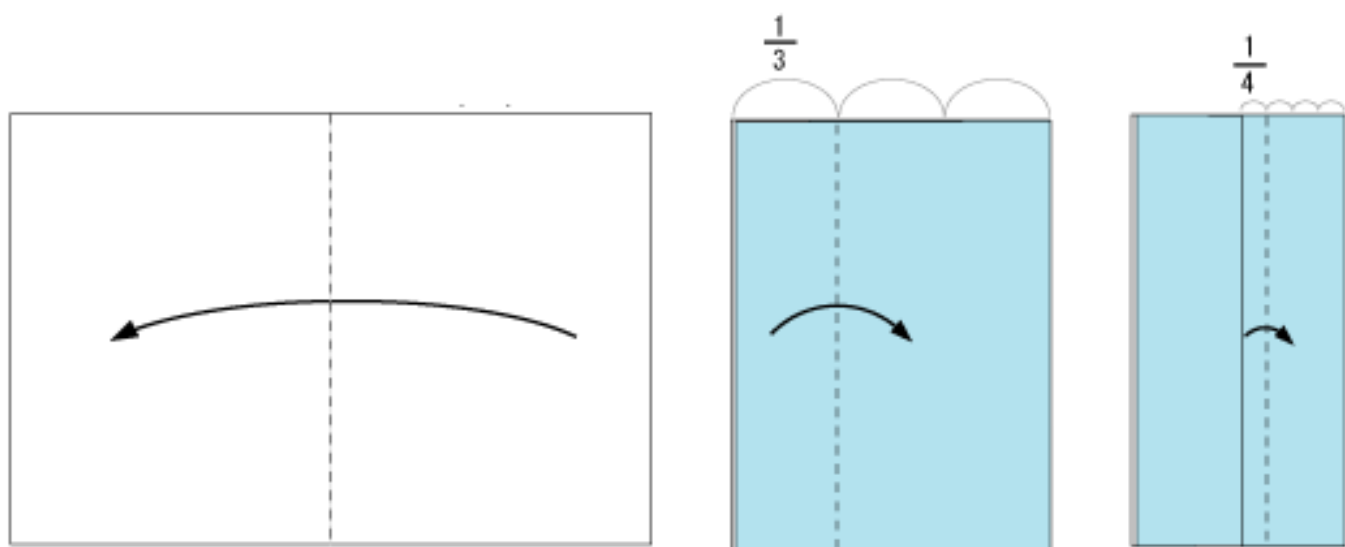

*Traditional
Diagram: Fumiaki Shingu

«САМОЛЕТ»

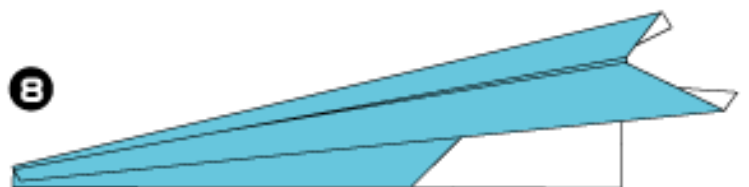
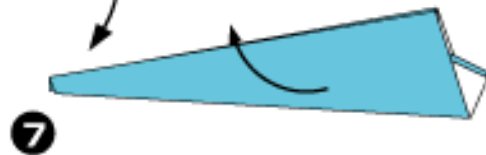
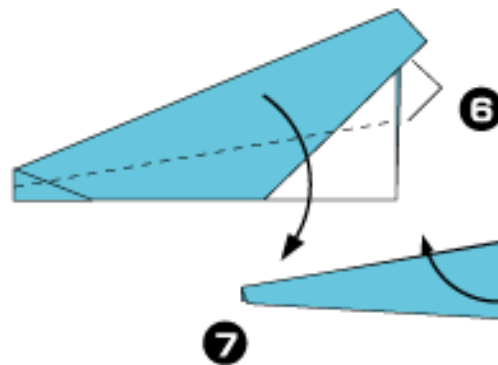
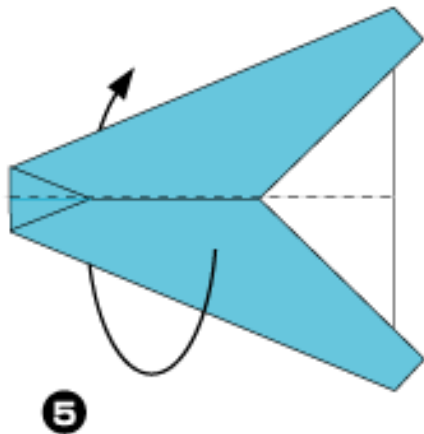
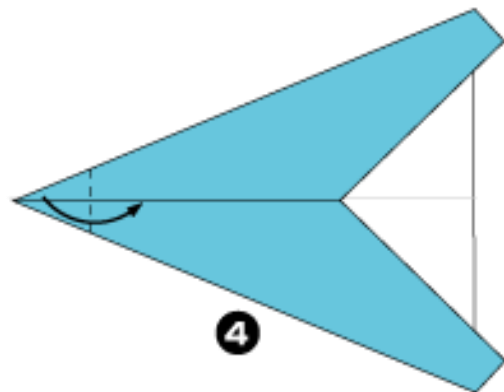
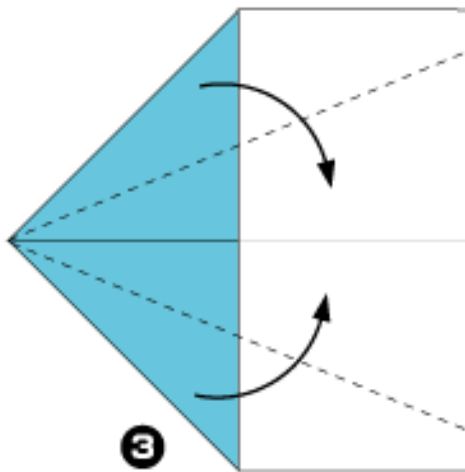
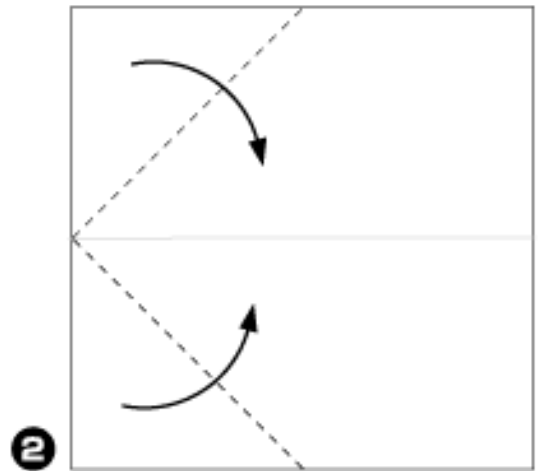
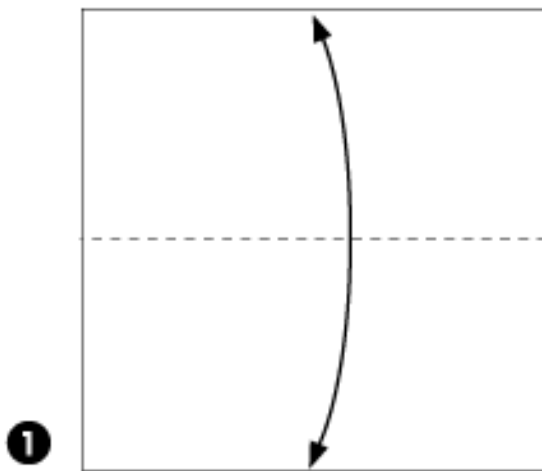

*Traditional
Diagram: Fumiaki Shingu

«ИСТРЕБИТЕЛЬ»

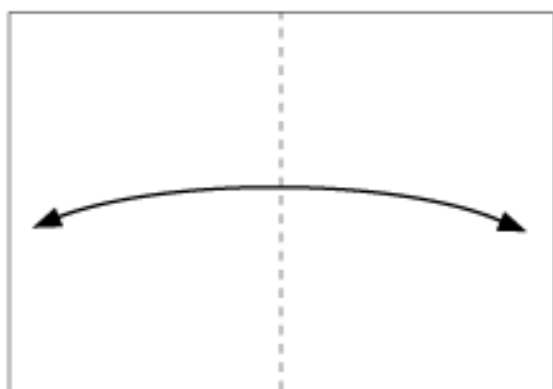

1

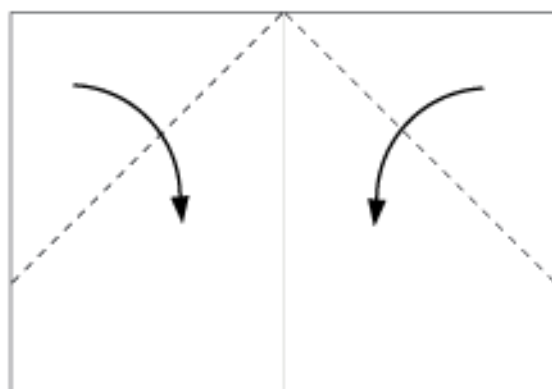

2

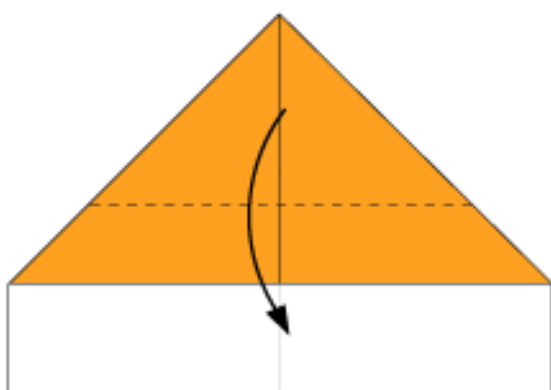

3

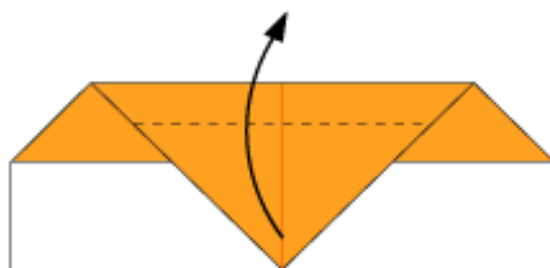

4

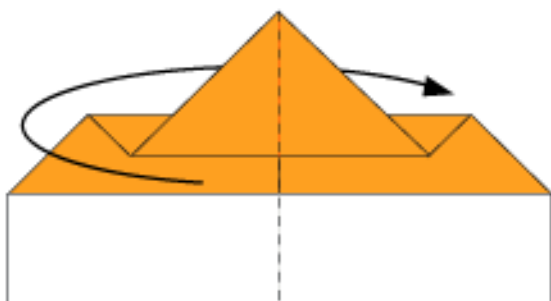

5

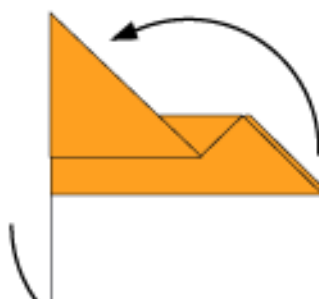

6

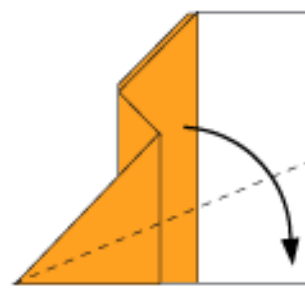

7

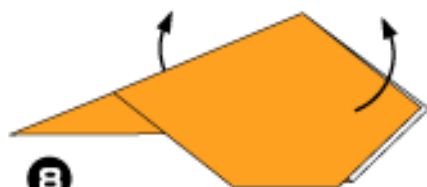

8

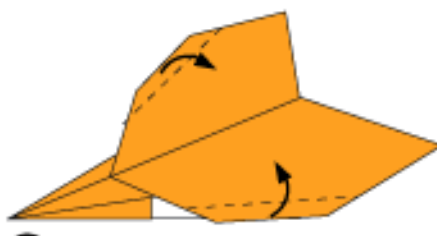

9

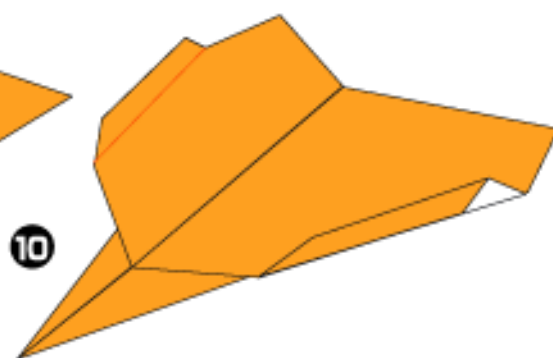

10

*Arrangement of Traditional
Diagram:Fumiaki Shingu

«КЛЕН»

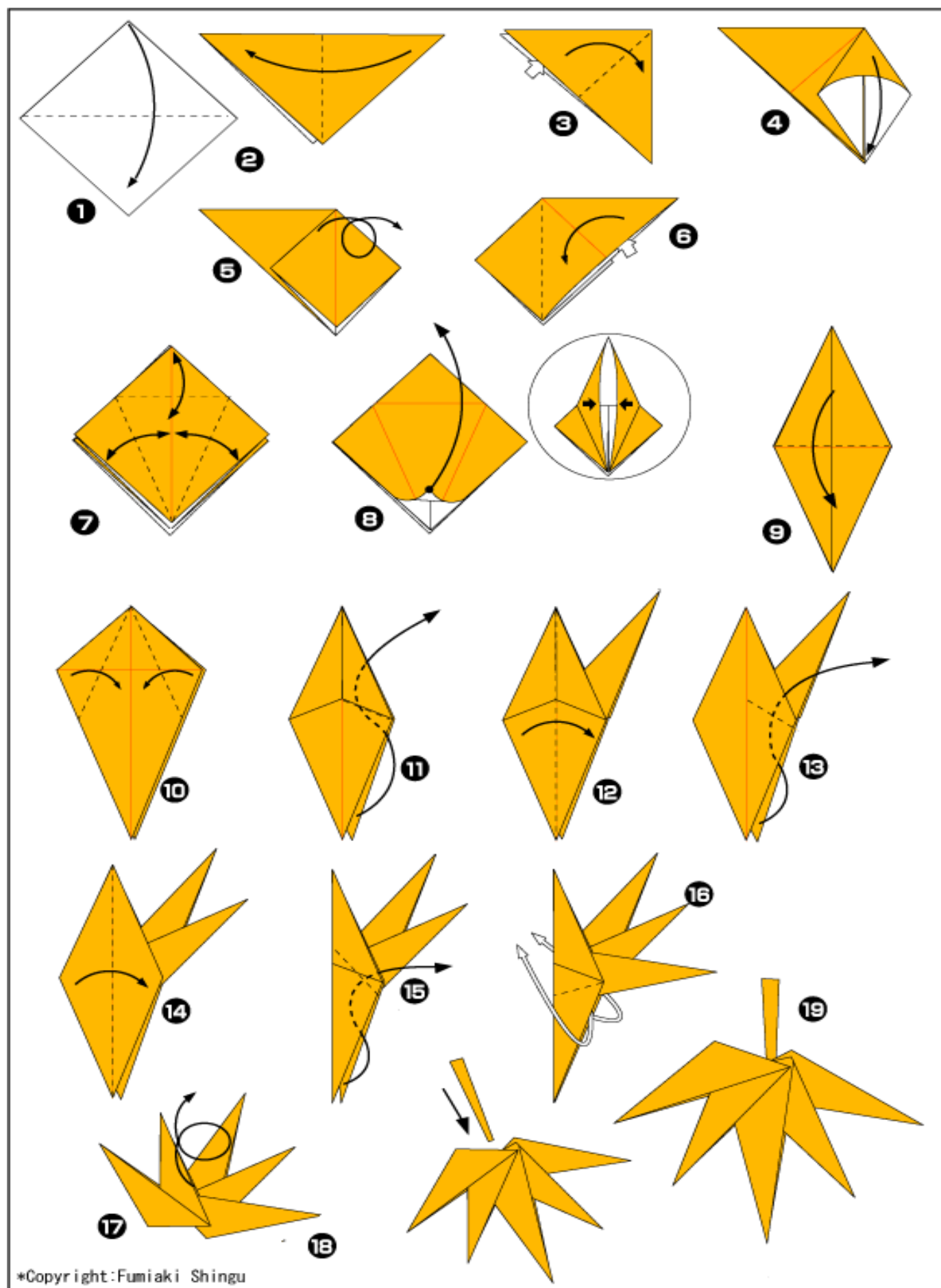

«РОЗА»

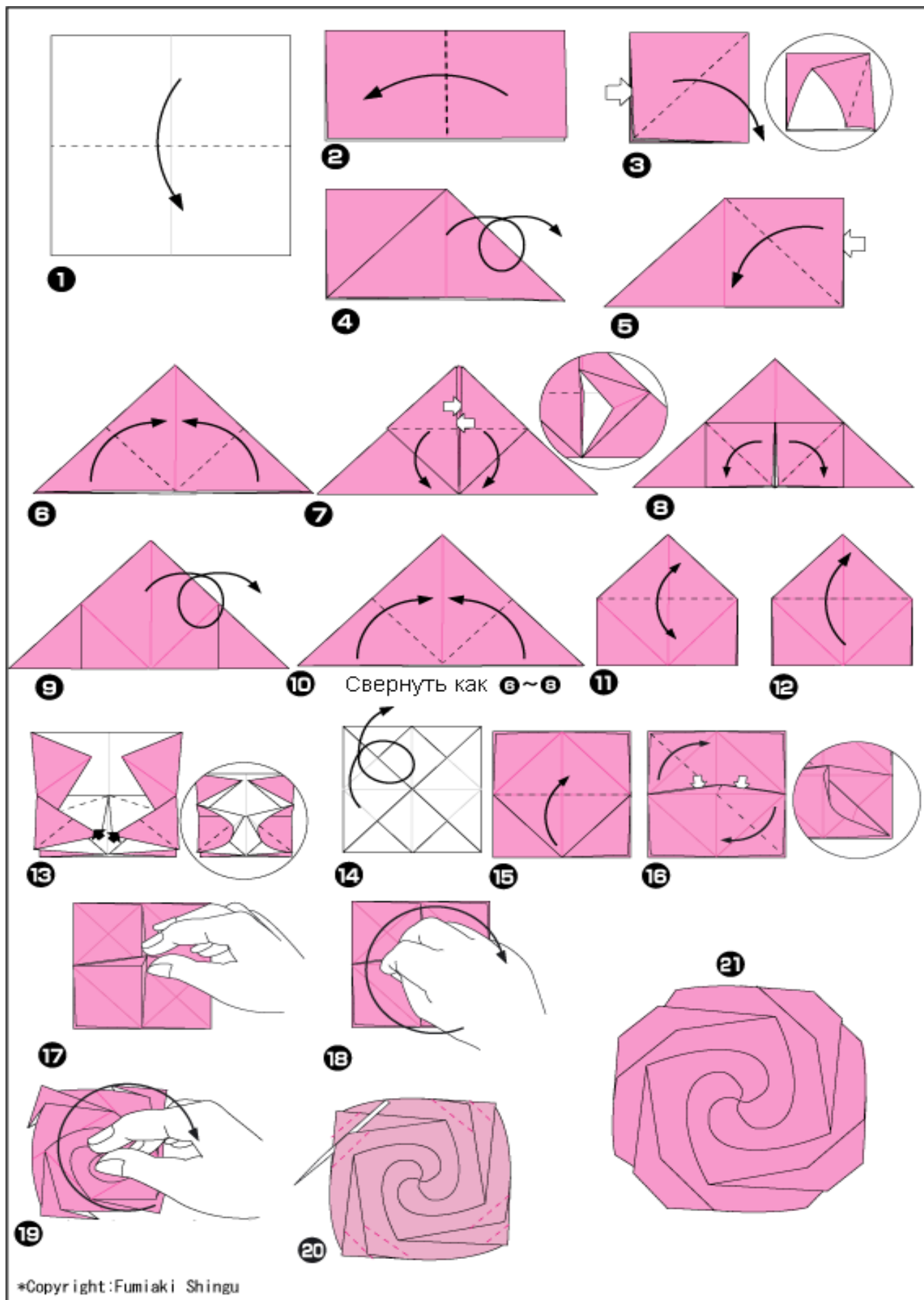

«КОНФЕТА»

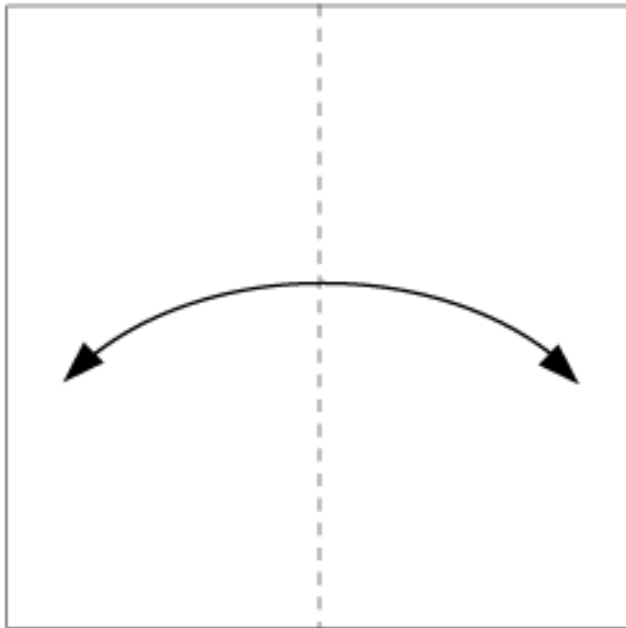

1

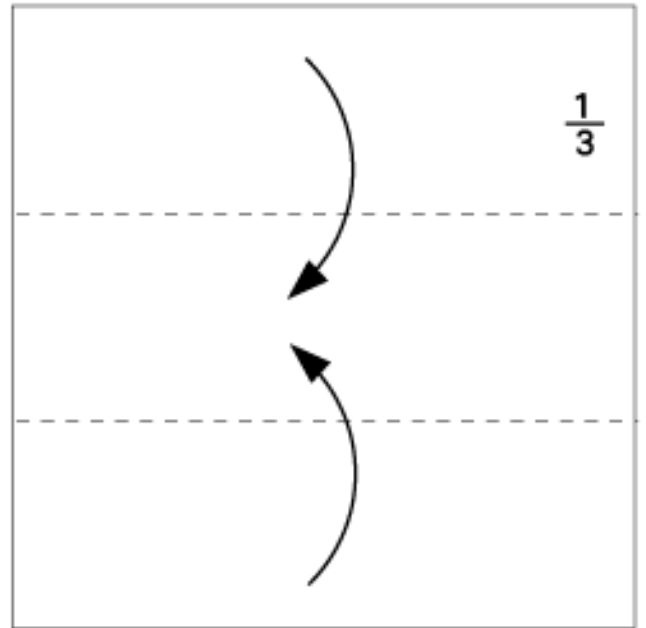

2

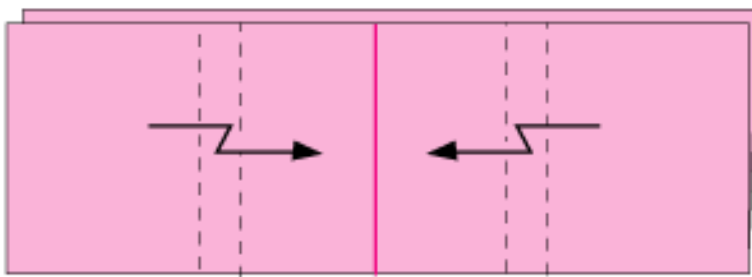

3

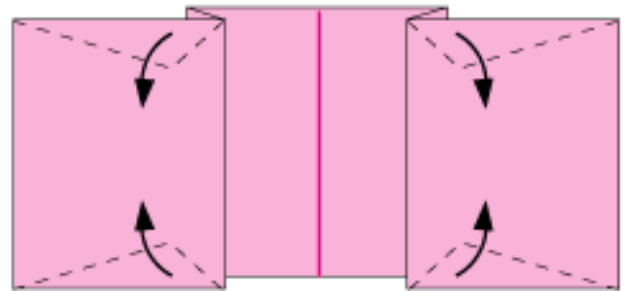

4

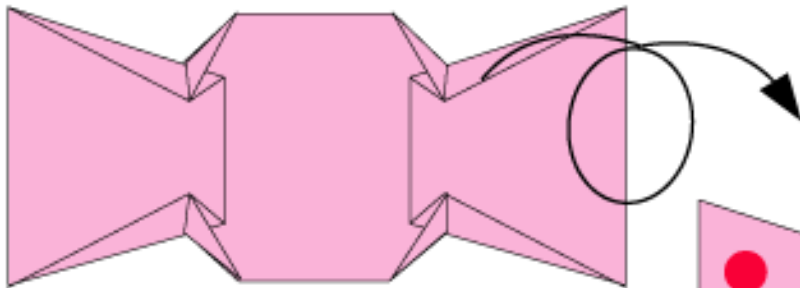

5

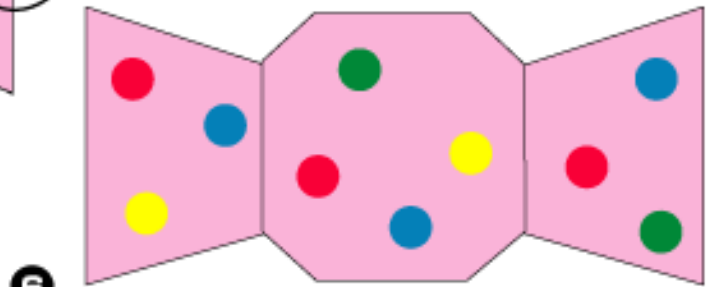

6

«СОЛНЦЕ»

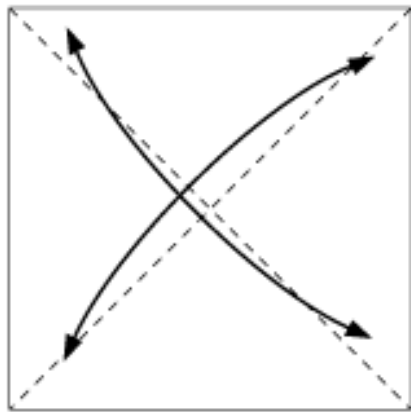

1

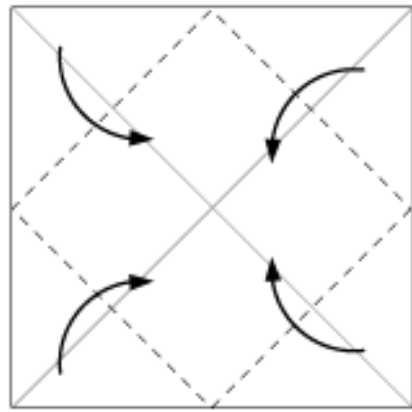

2

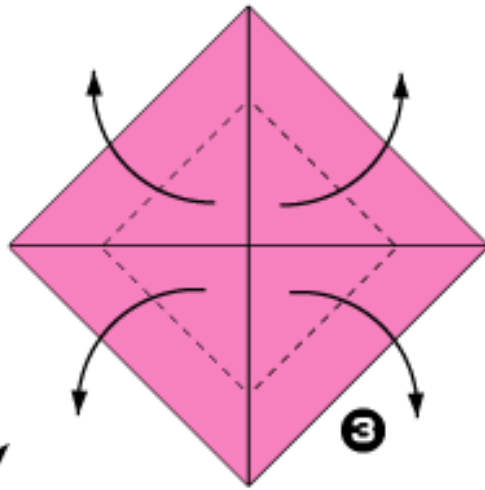

3

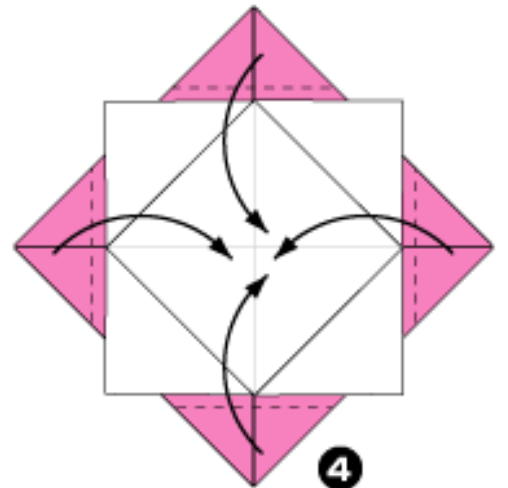

4

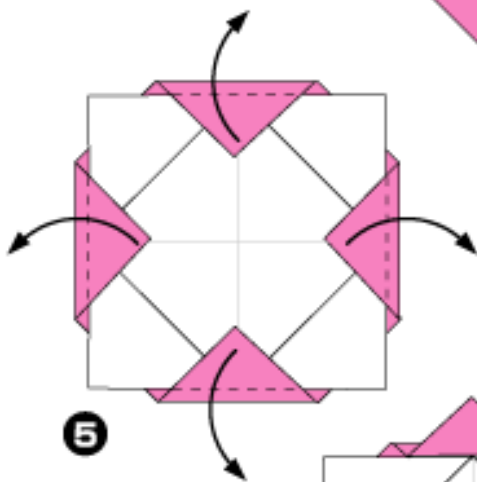

5

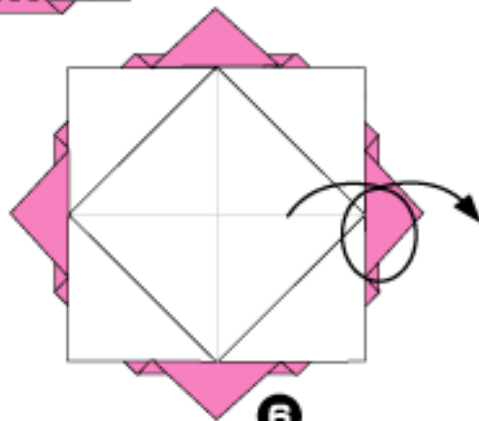

6

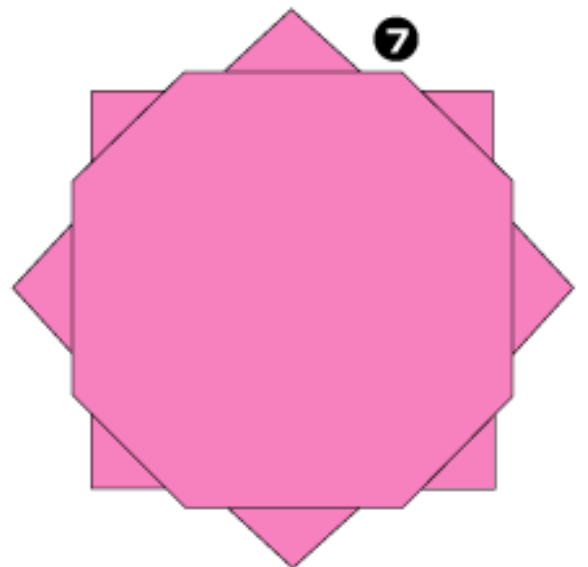

7