

КАРТОТЕКА СХЕМ ОРИГАМИ ДЛЯ СРЕДНЕГО ДОШКОЛЬНОГО ВОЗРАСТА

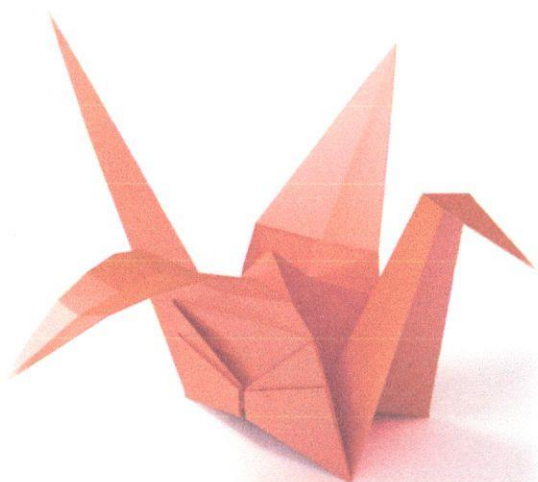

Автор-составитель:
Карканица Наталья Сергеевна,
воспитатель
МБДОУ г. Иркутска детского сада № 28

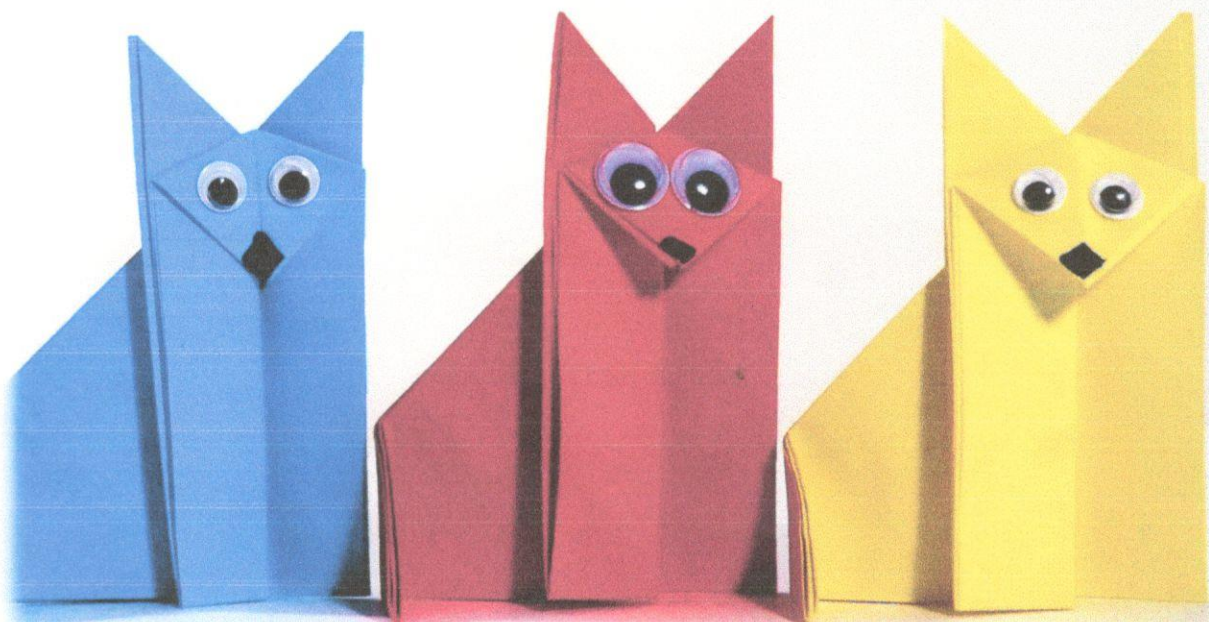

Условные обозначения



повернуть

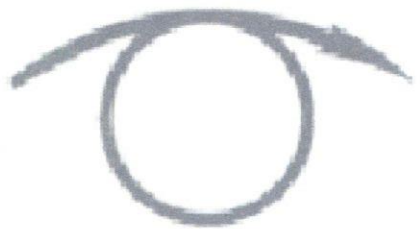
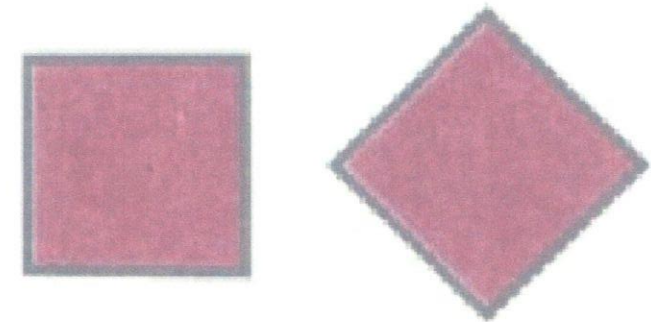

перевернуть на обратную сторону

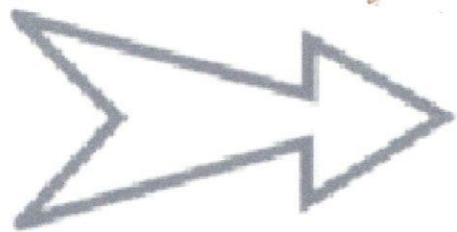
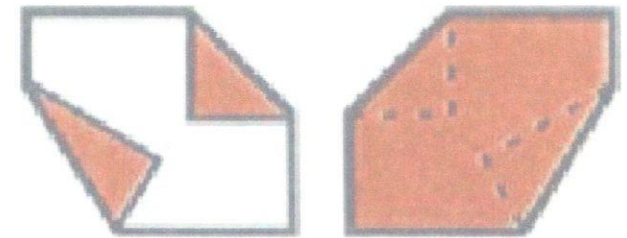

расправить

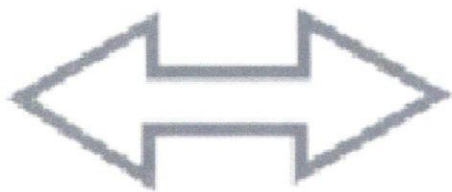
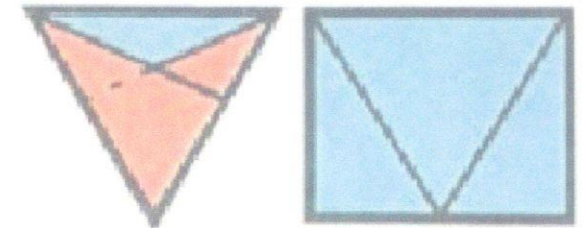

склеить, соединить

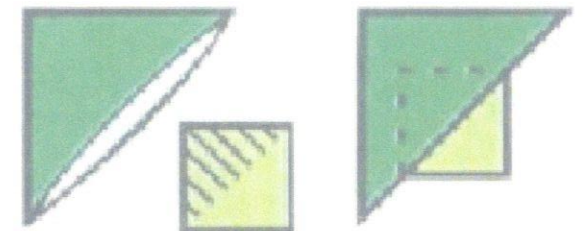

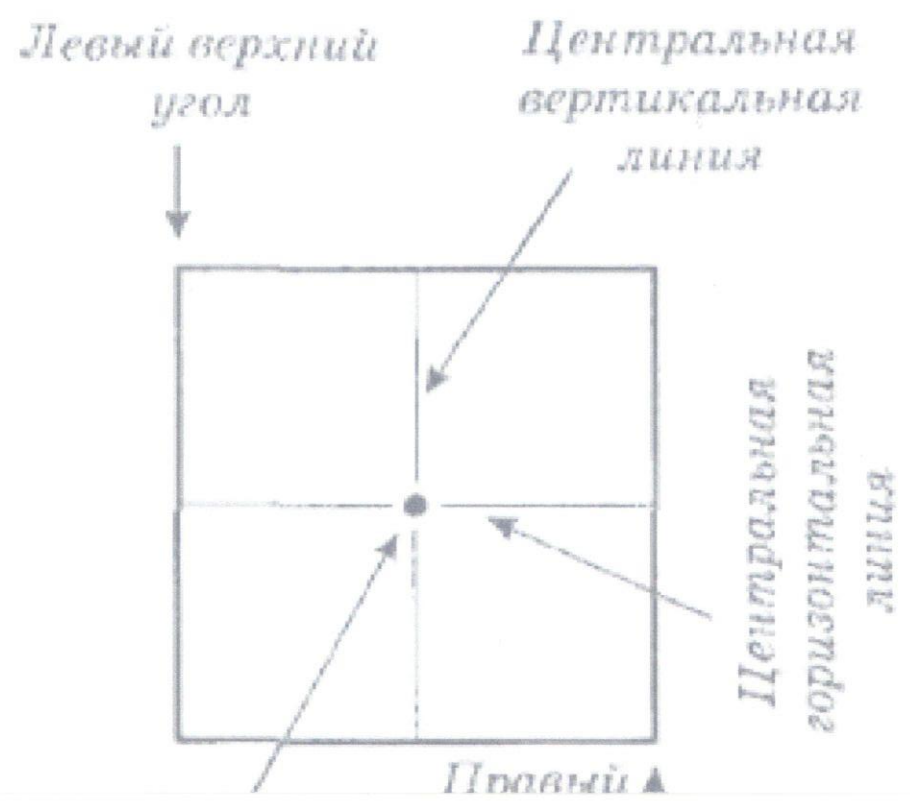
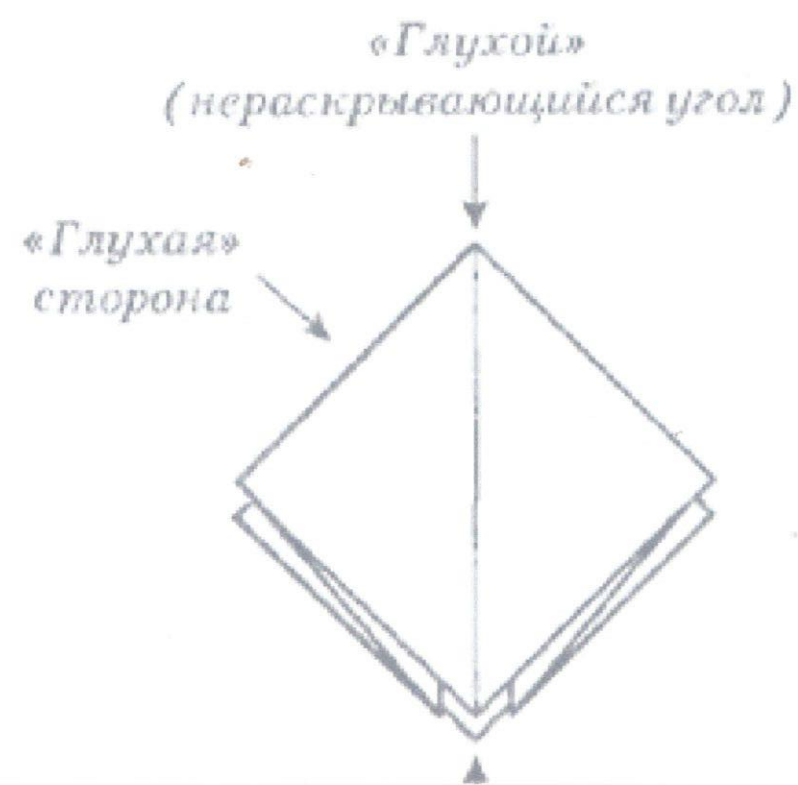
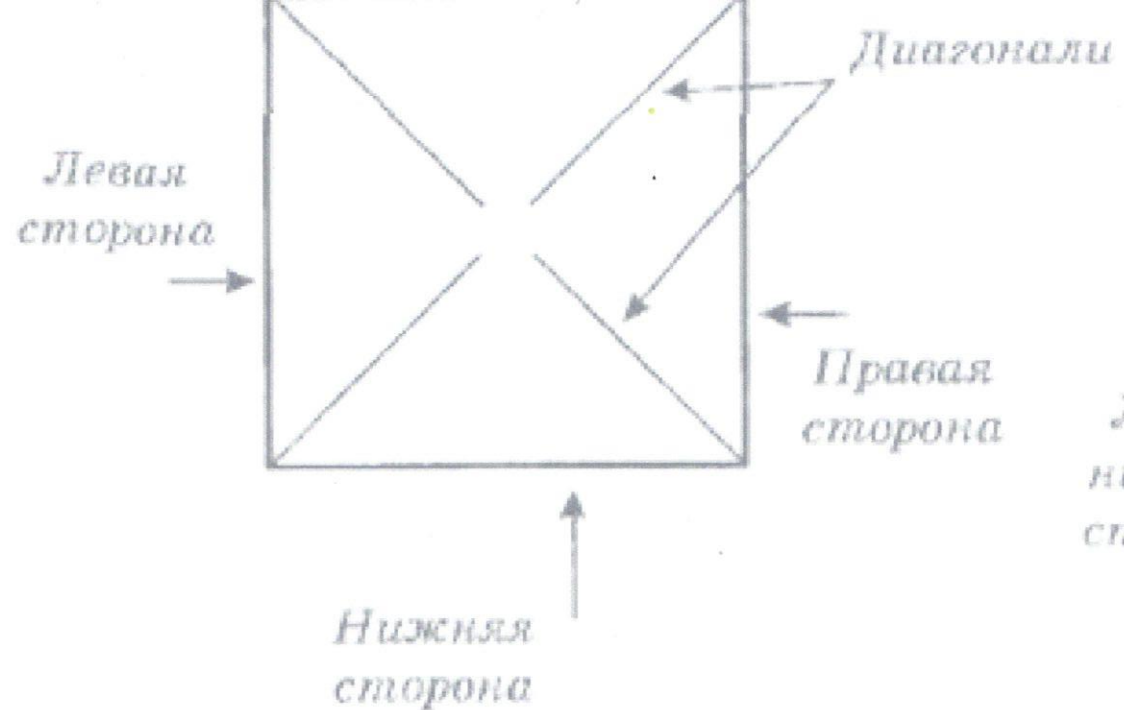

Школа оригами.

Условные обозначения.

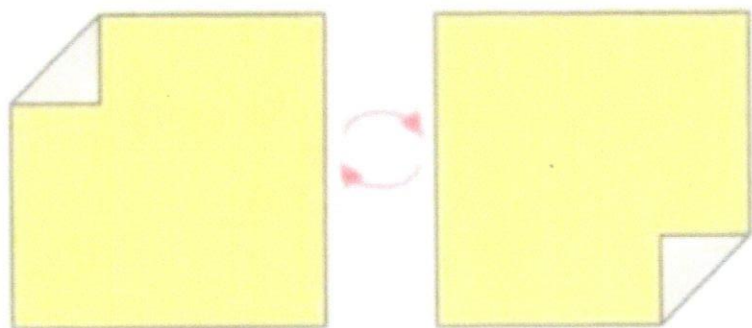

Повернуть в одной плоскости.

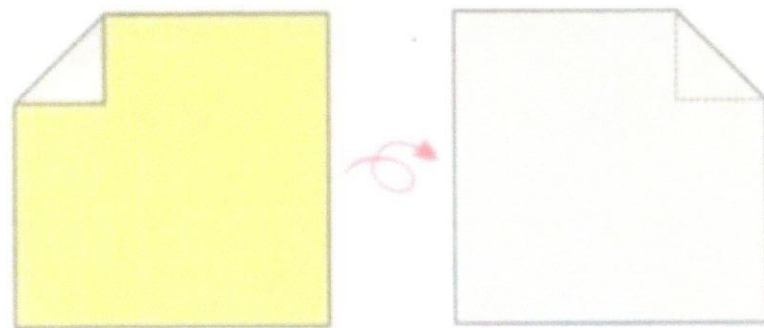

Перевернуть.

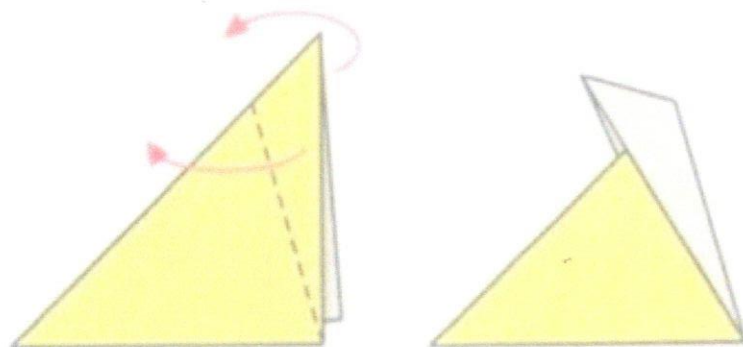

Выгнуть наружу.

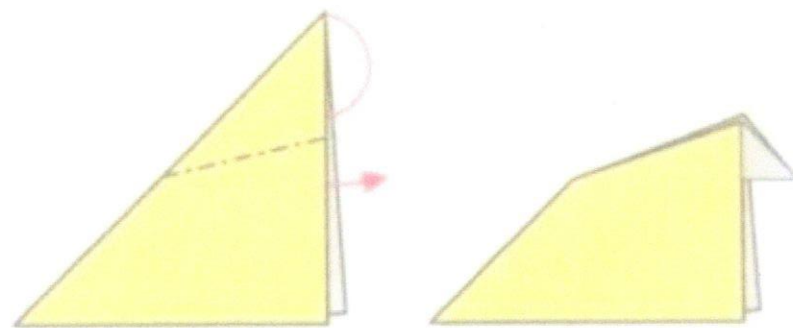

Вогнуть внутрь.

Школа оригами.

Условные обозначения.

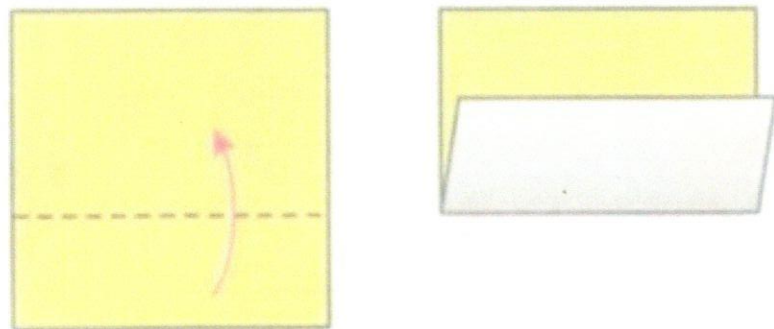

Сгиб «долиной».

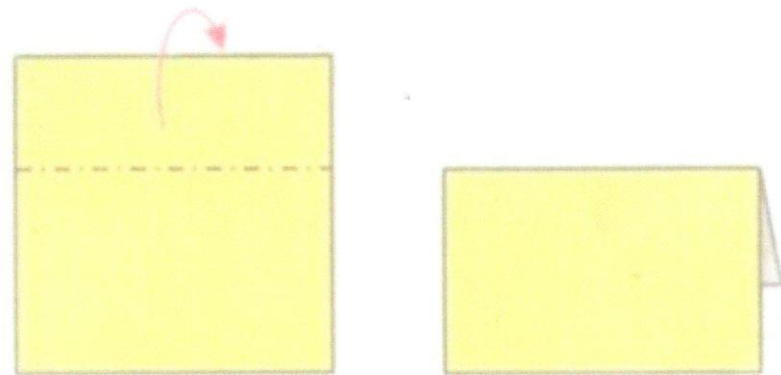

Сгиб «горой».

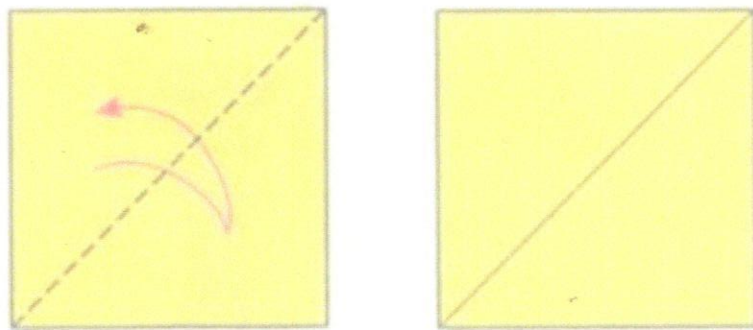

Перегнуть — наметить складку.

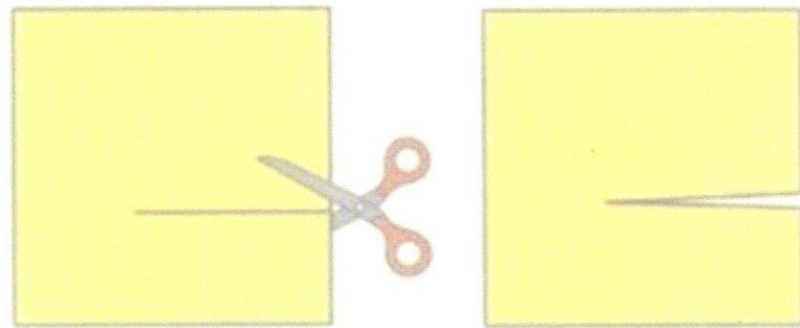

Надрезать.

ОРИГАМИ «СОБАКА»

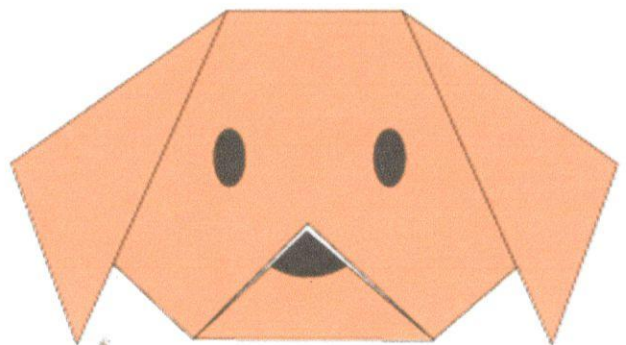
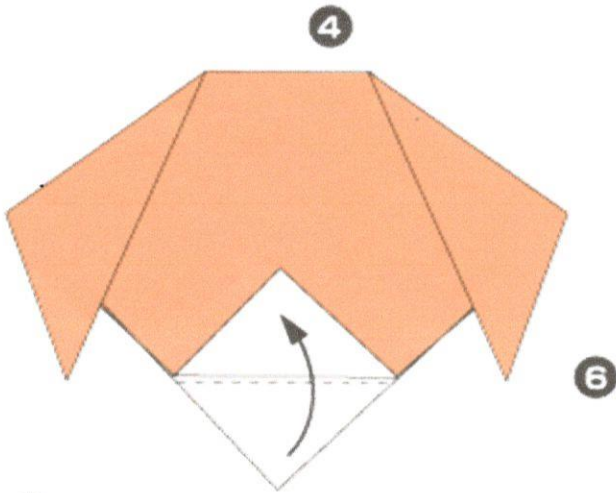
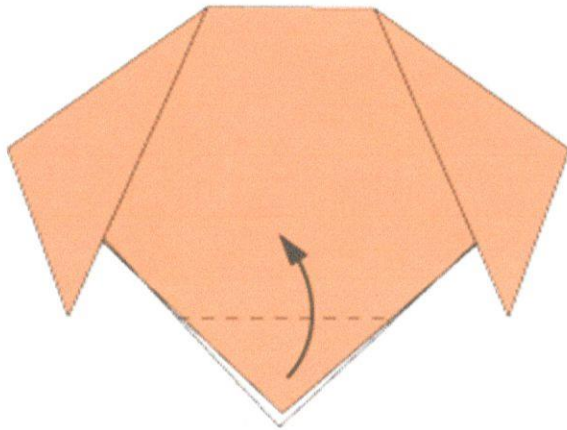
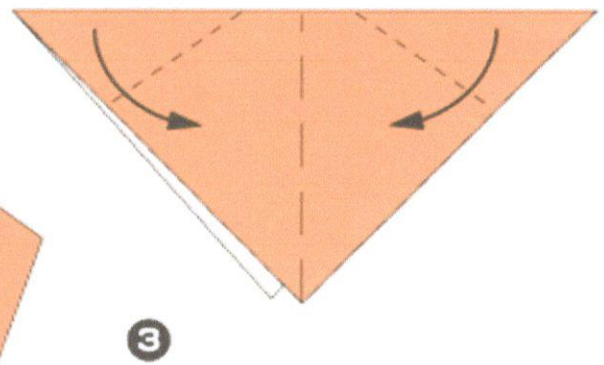
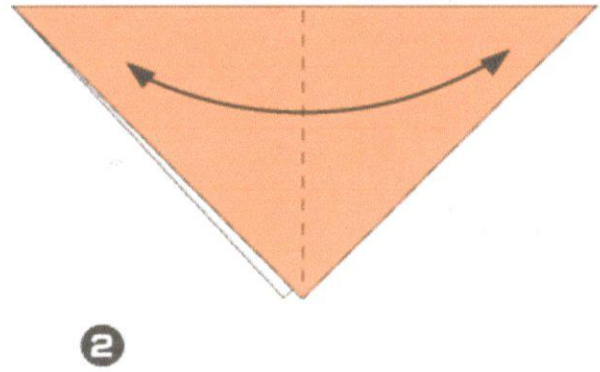
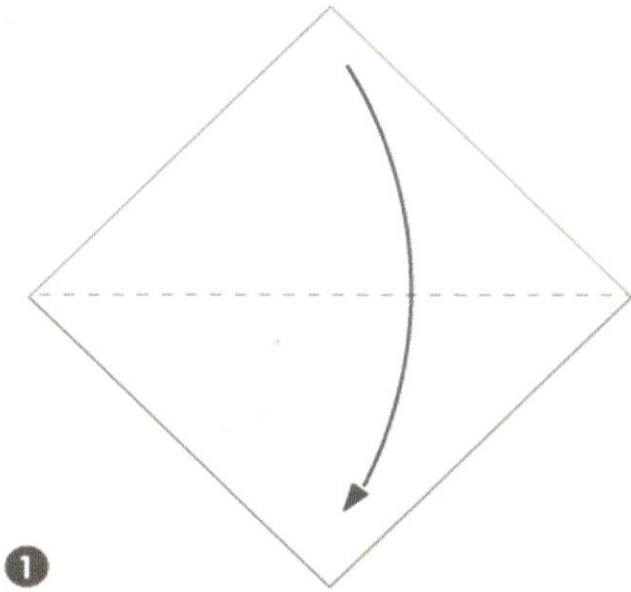

*Traditional
Diagram: Fumiaki Shingu

ОРИГАМИ «КИТ»

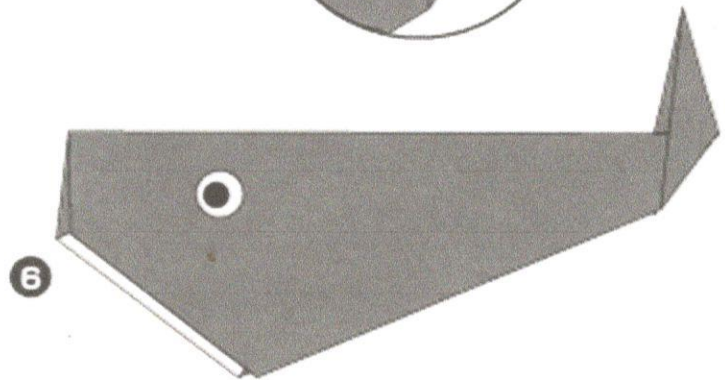
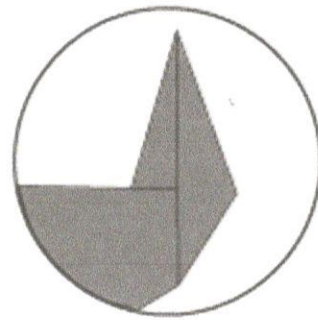
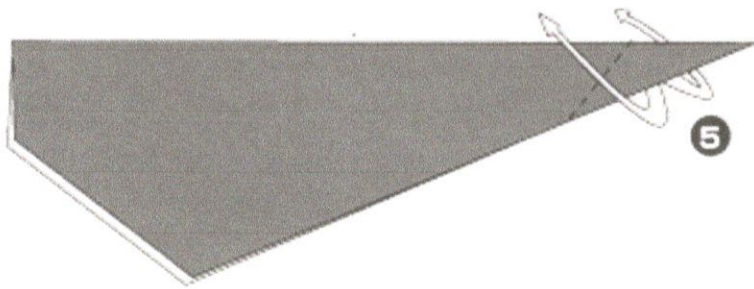
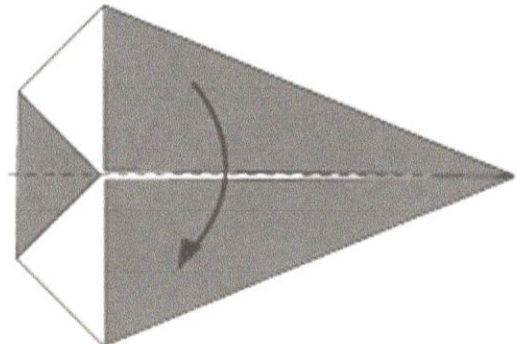
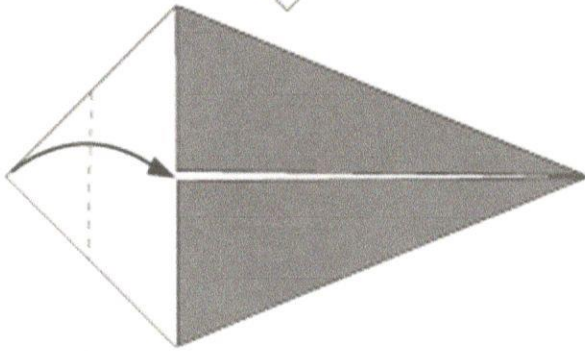
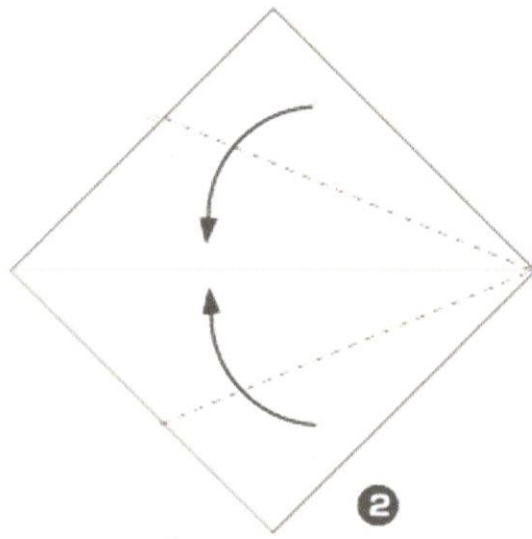
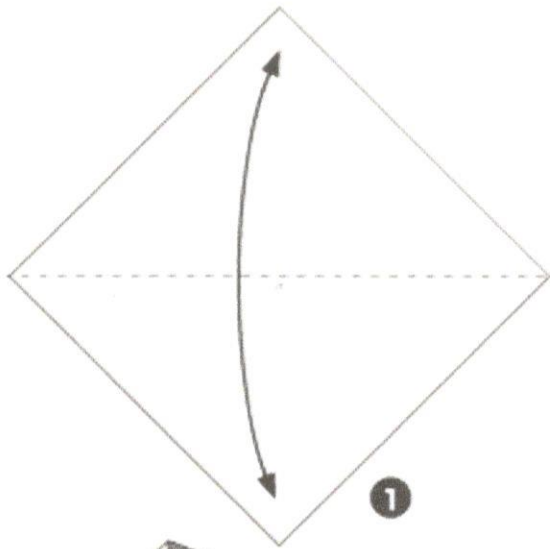

ОРИГАМИ «ЯХТА»

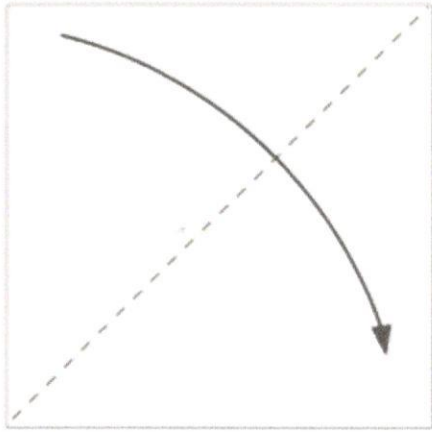

1

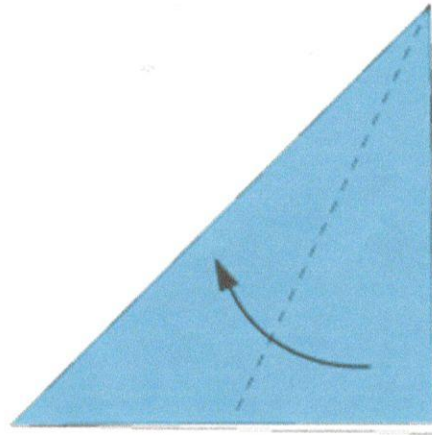

2

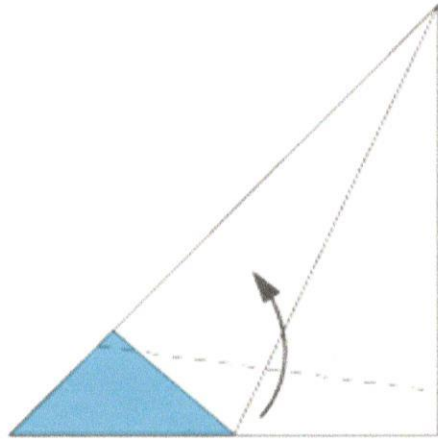

3

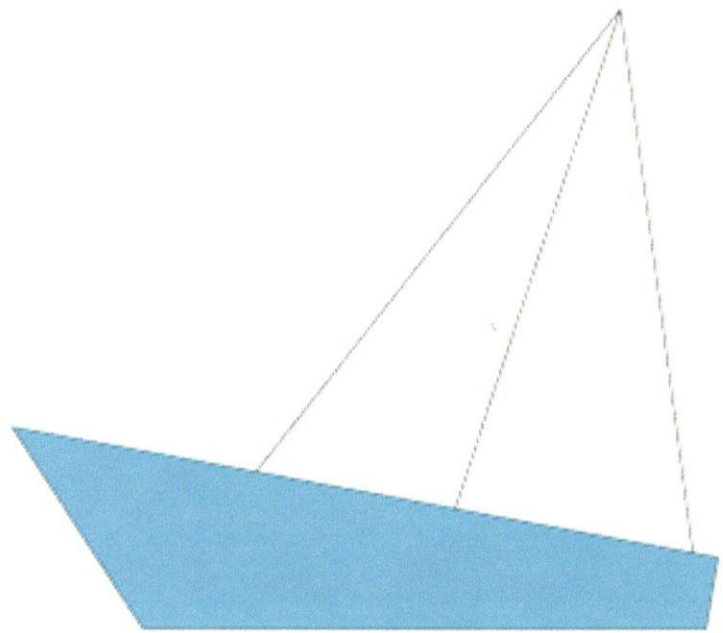

4

ОРИГАМИ «РЫБА»

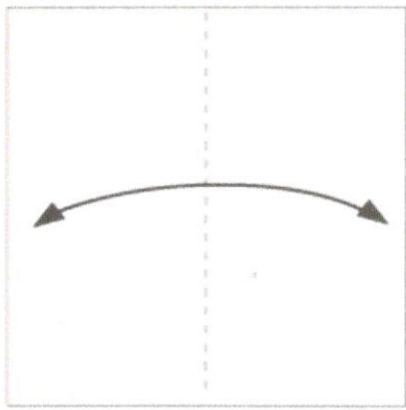

1

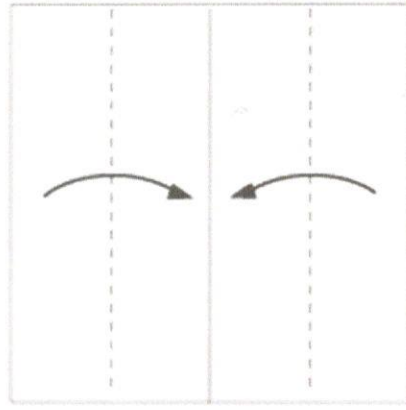

2

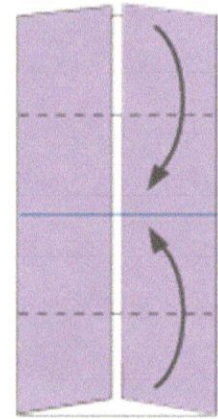

3

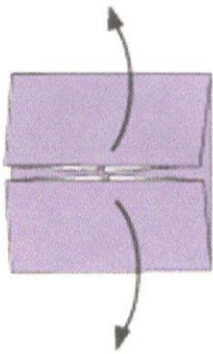

4

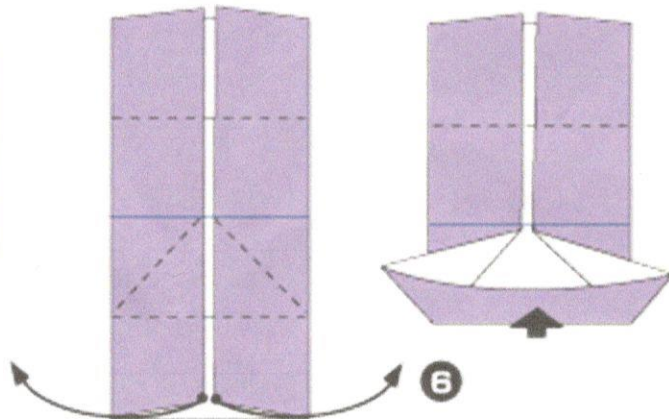

5

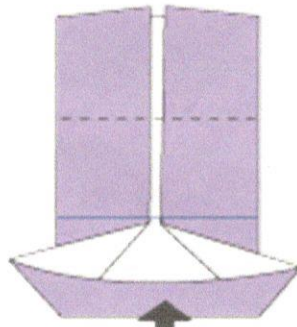

6

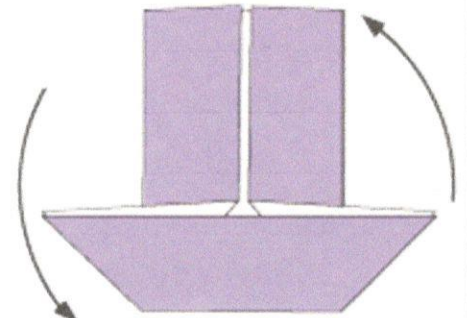

7

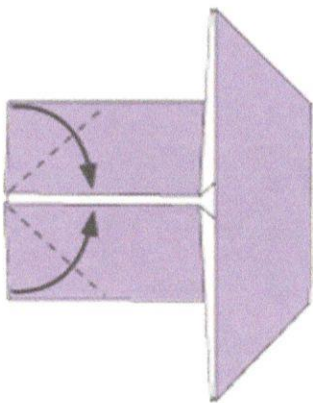

8

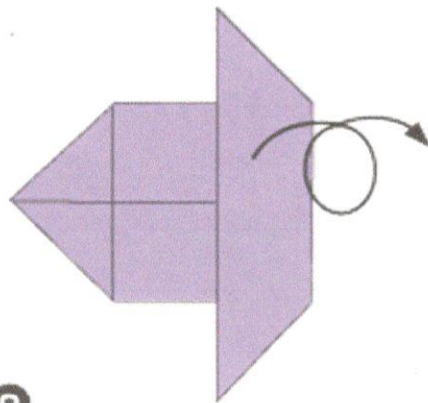

9

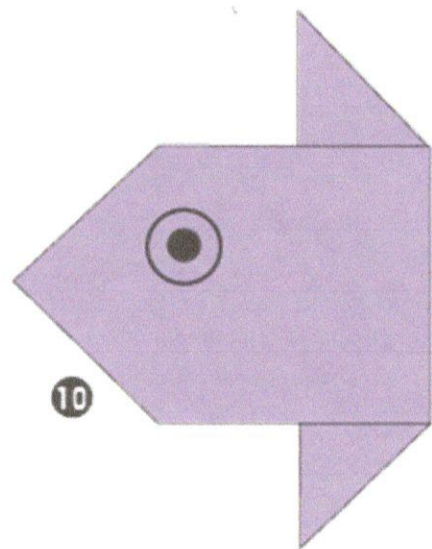

10

ОРИГАМИ «ТЮЛЬПАН»

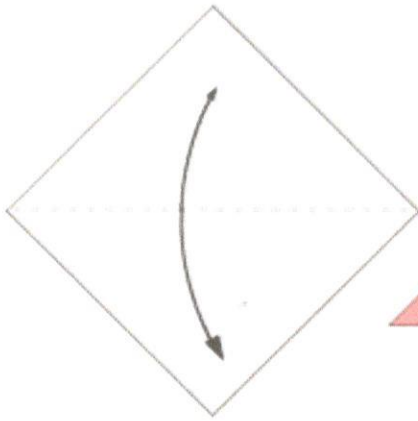

1

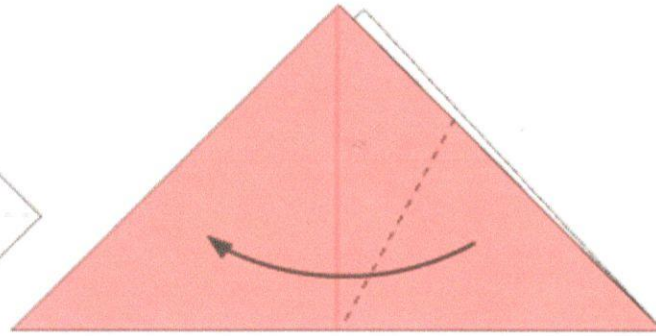

2

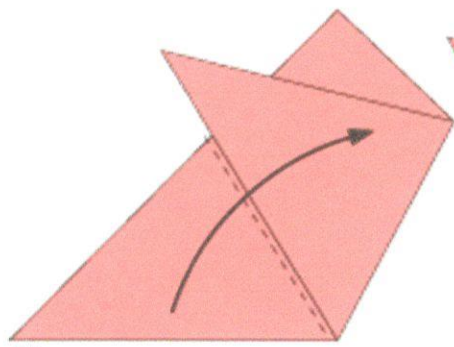

3

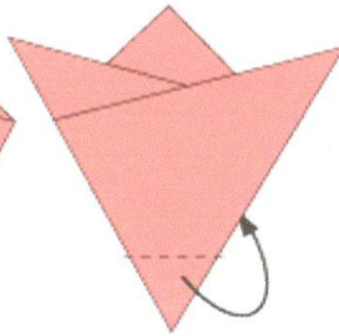

4

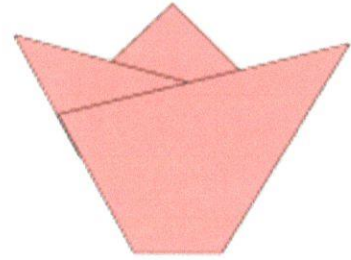

5

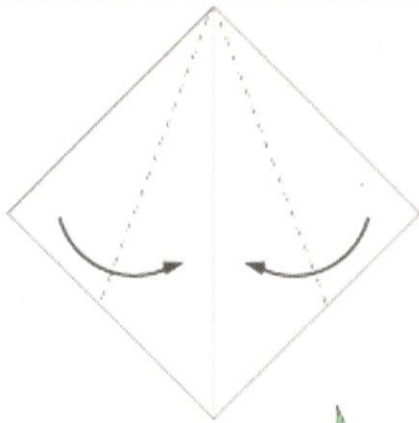

1

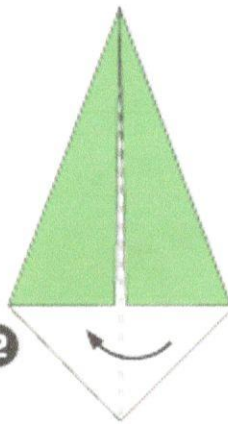

2

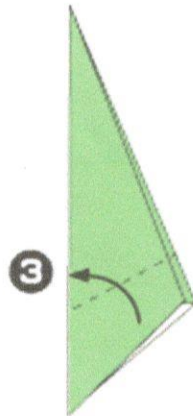

3

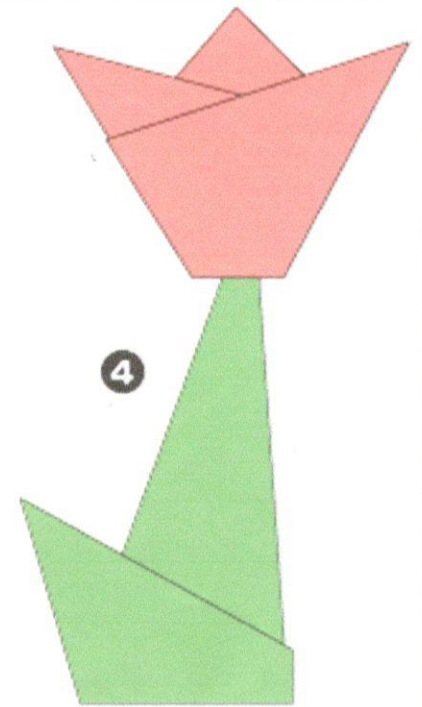

4

«БАБОЧКА»

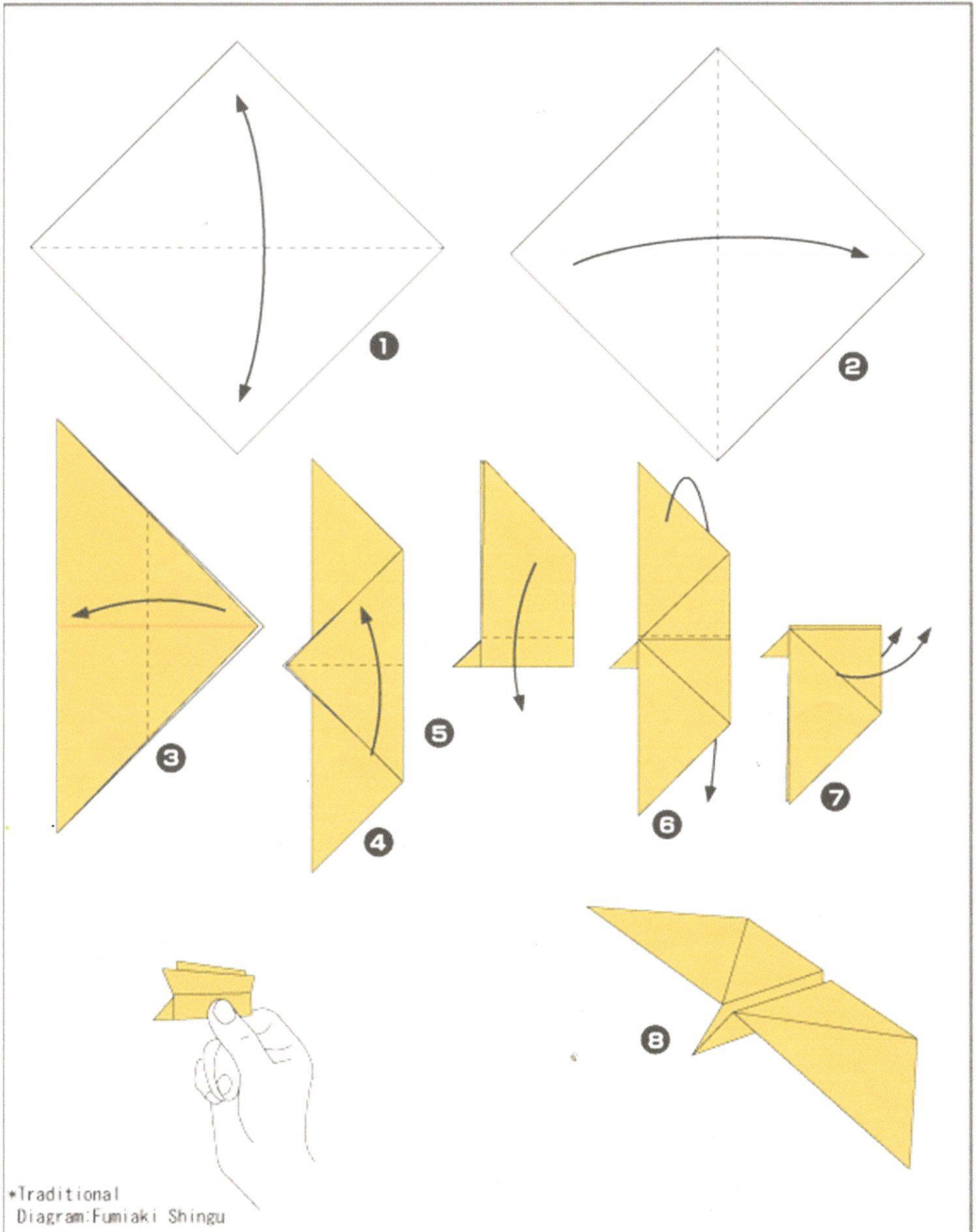

«РУБАШКА»

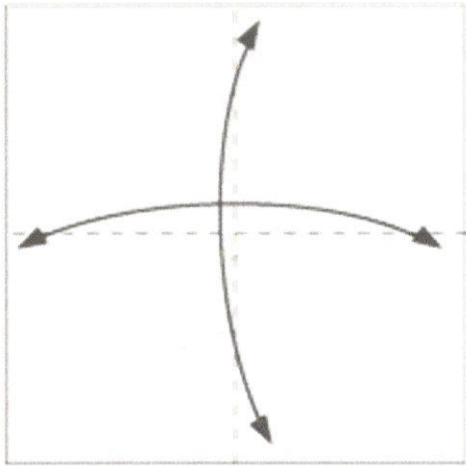

1

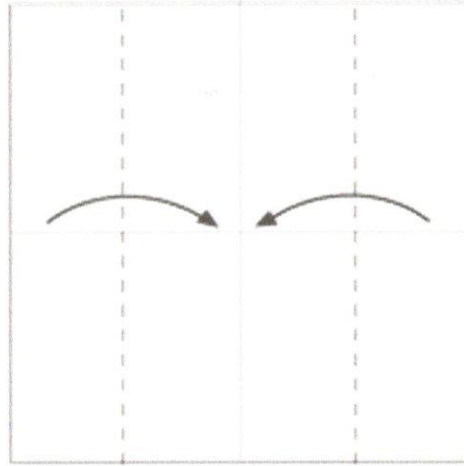

2

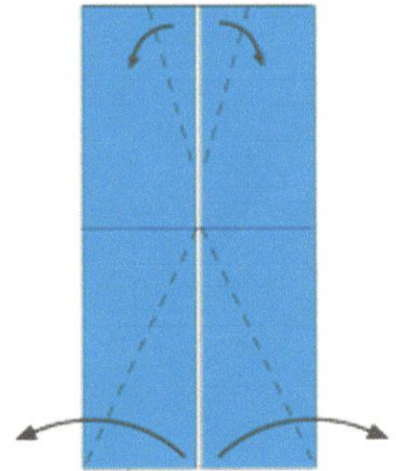

3

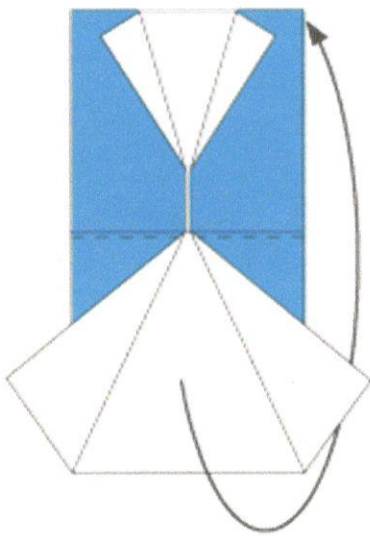

4

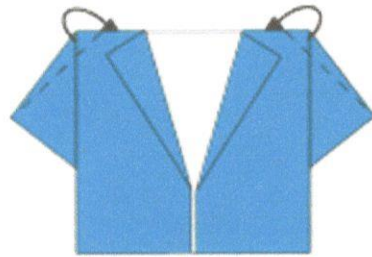

5



6

«ПЛАТЬЕ»

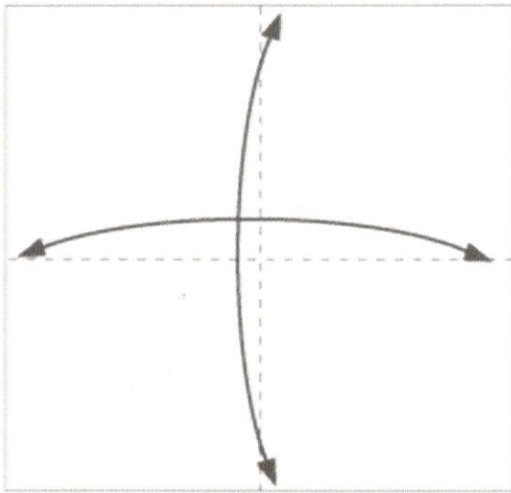

1

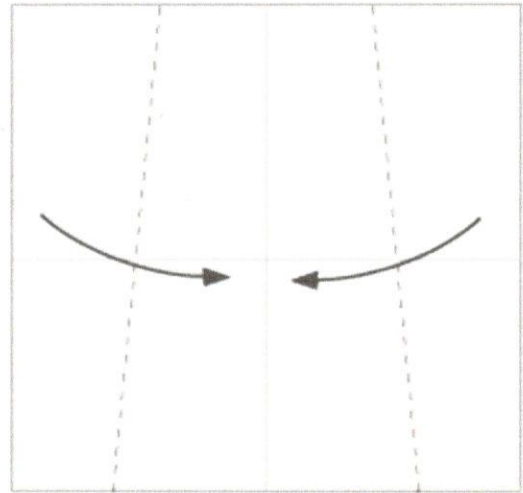

2

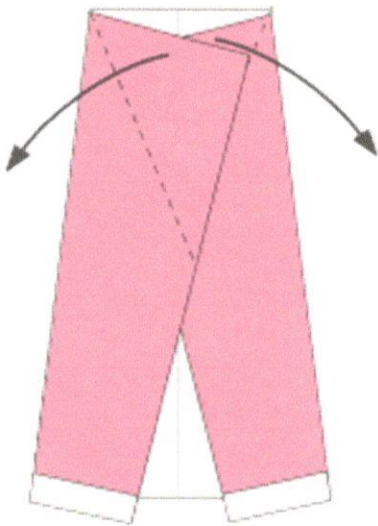

3

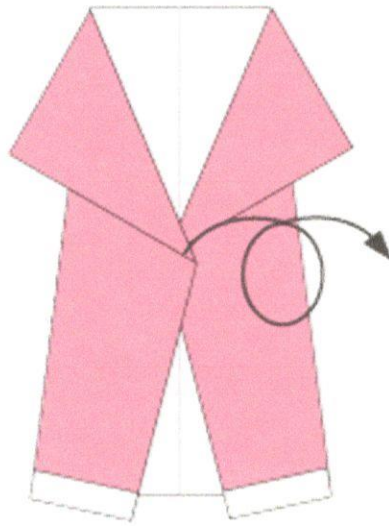

4



5

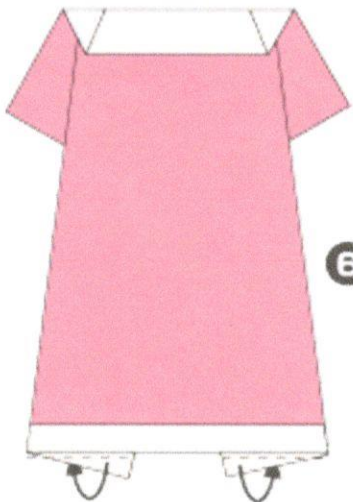

6

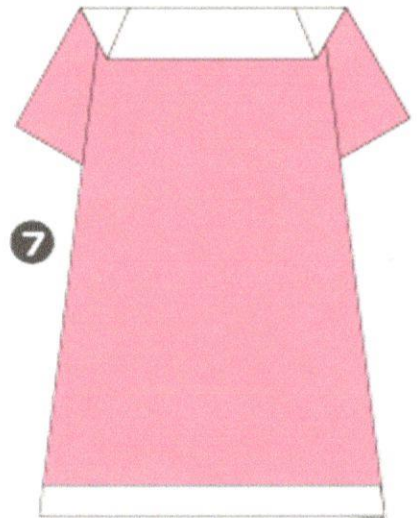

7

«ХОМЯК»

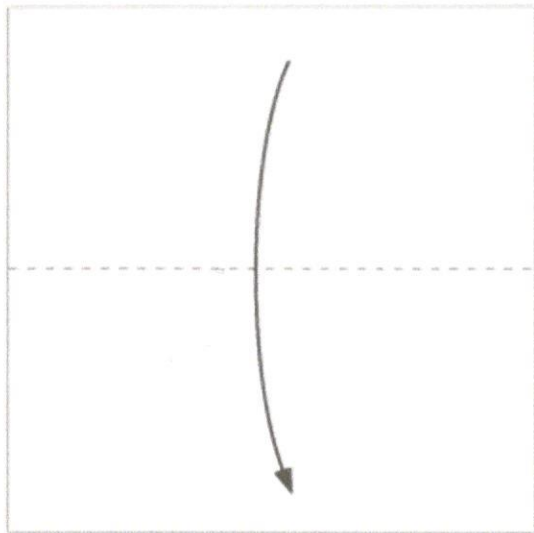

1

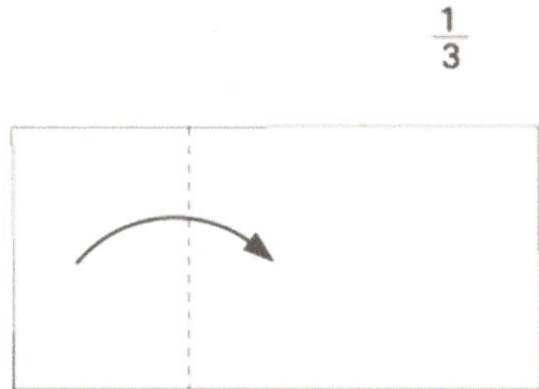

2

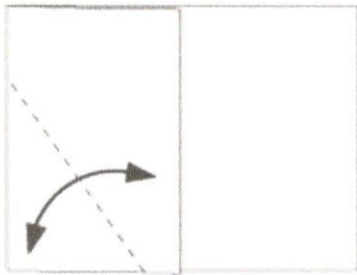

3

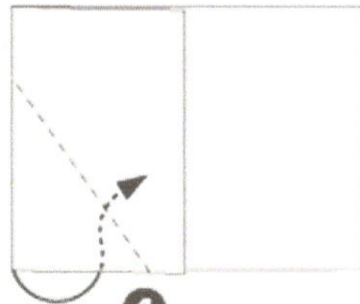

4

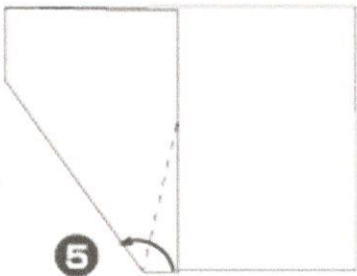

5

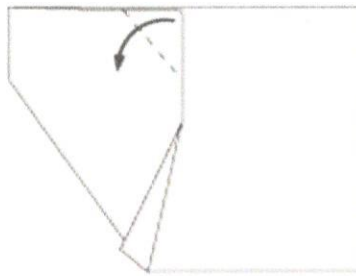

6

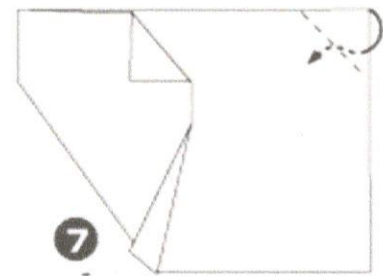

7

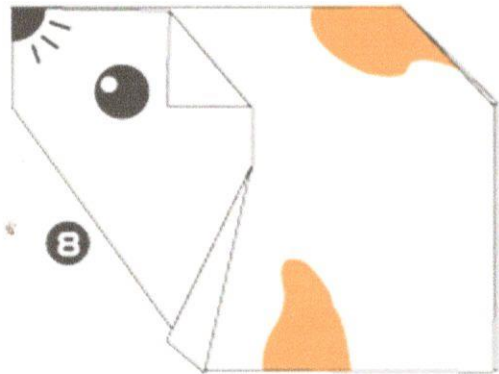
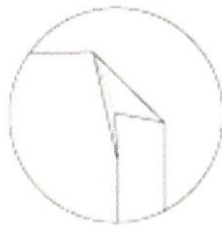

8

«БАНАНЫ»

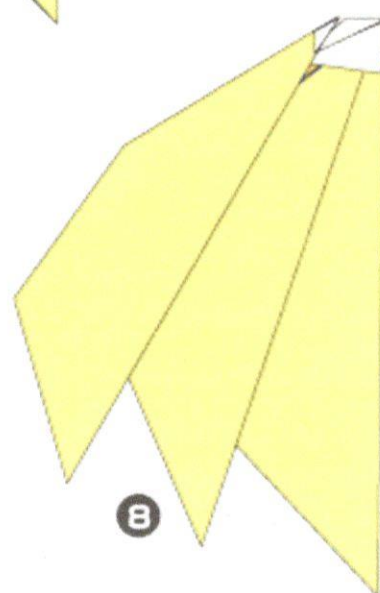
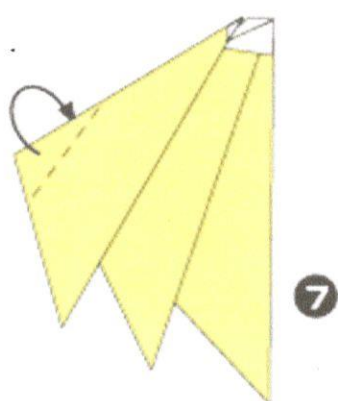
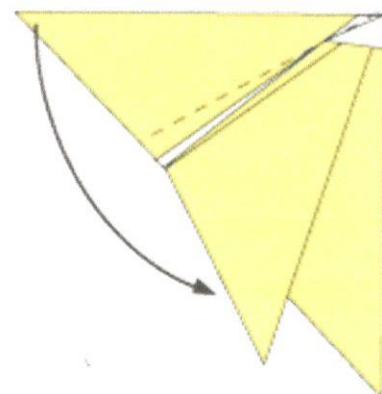
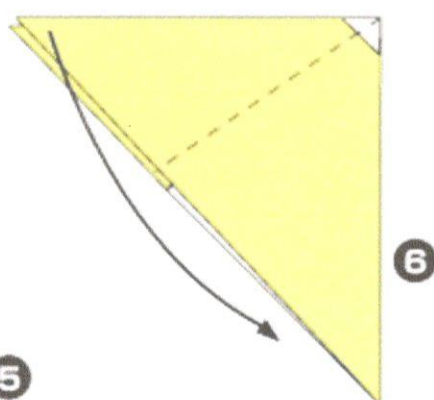
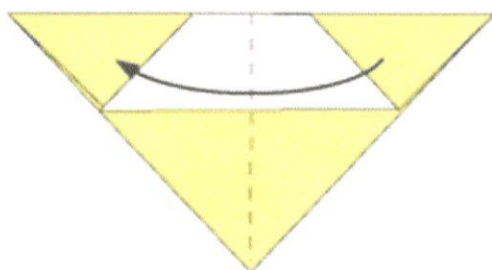
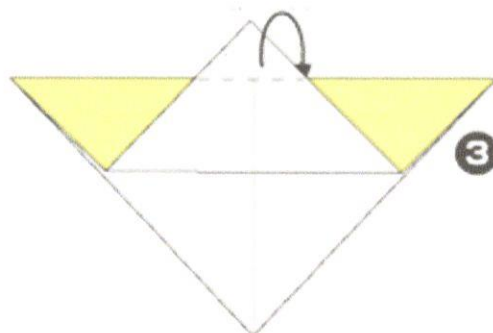
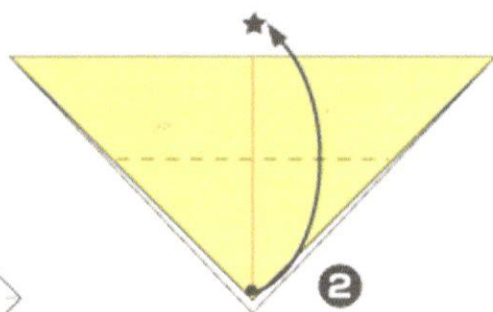
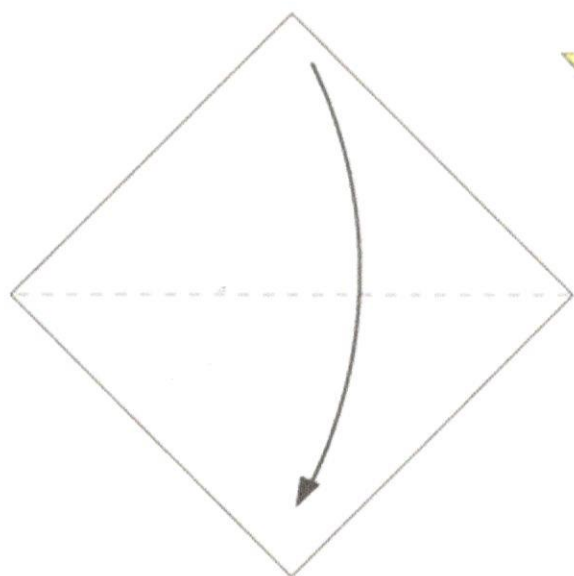

«ДОМ»

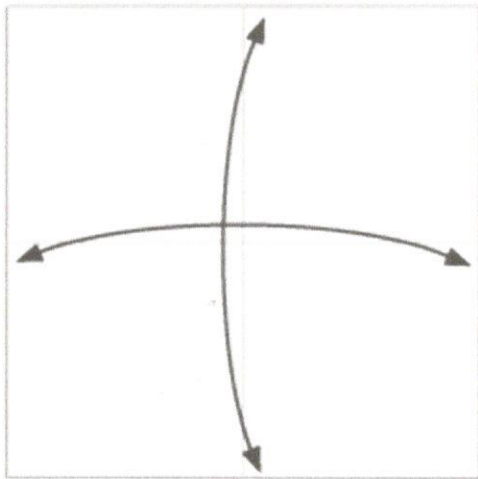

1

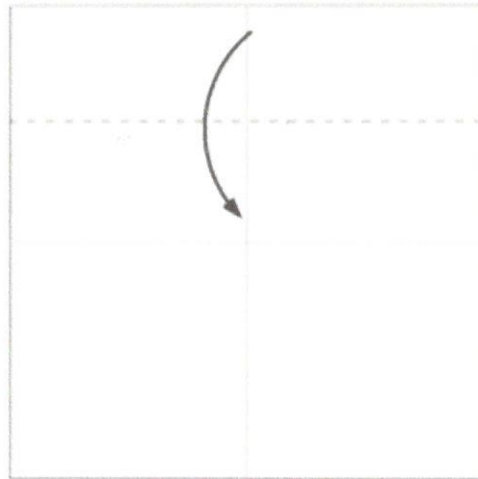

2

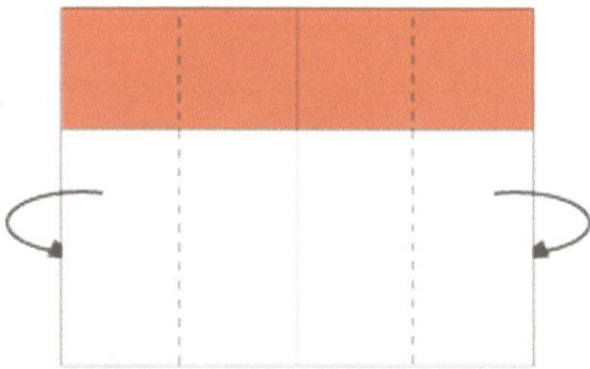

3

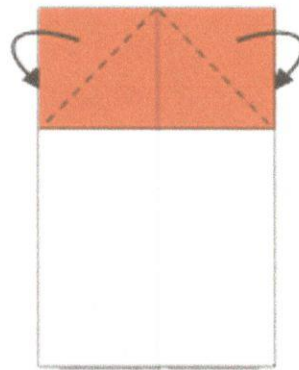

4

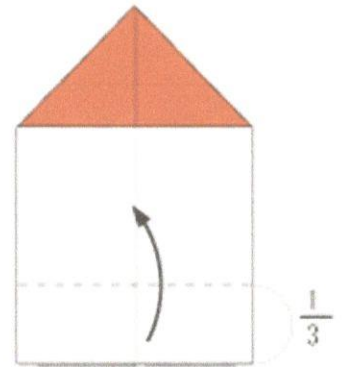

5

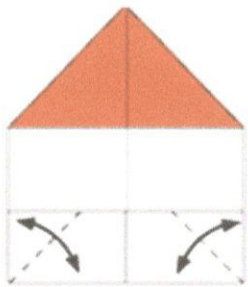

6

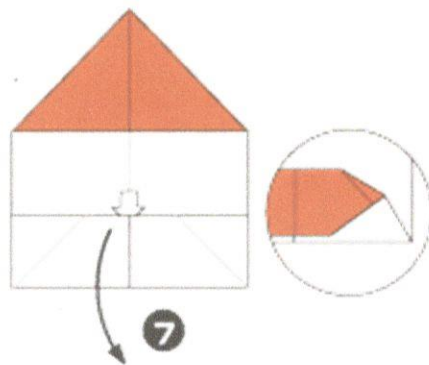

7

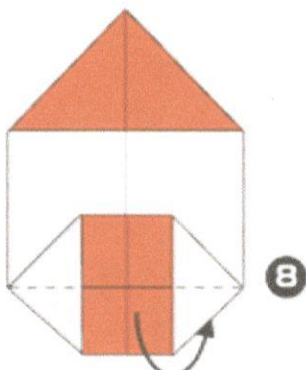

8

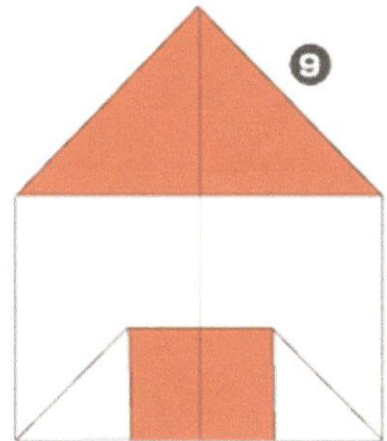

9

«ШАПКА»

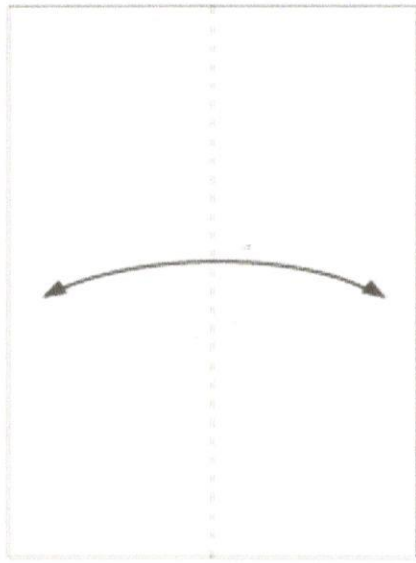

1

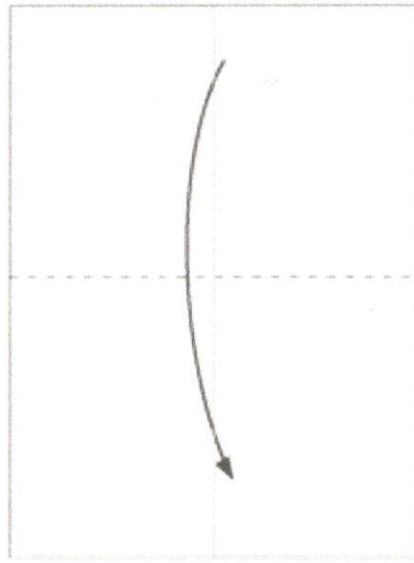

2

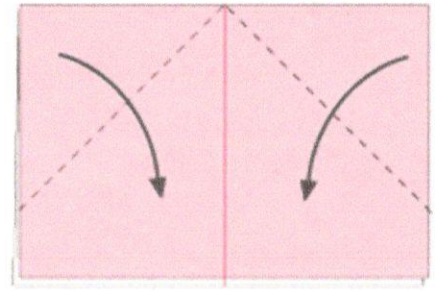

3

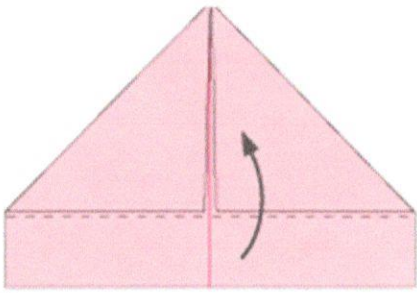

4

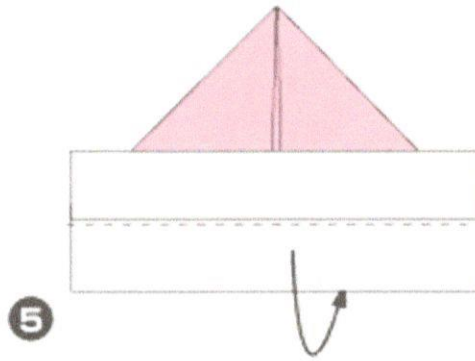

5

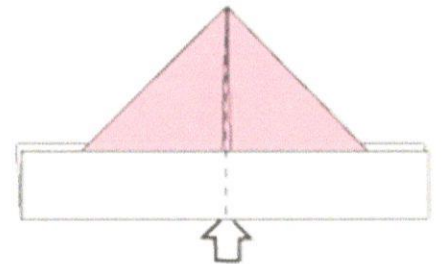

6

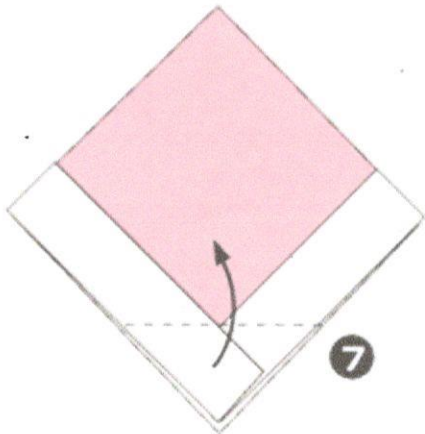

7

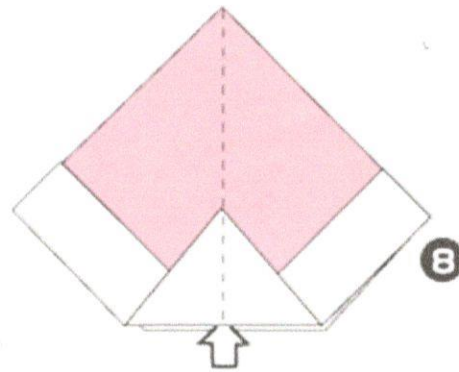

8

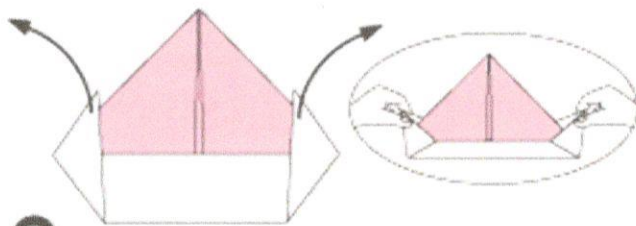

9

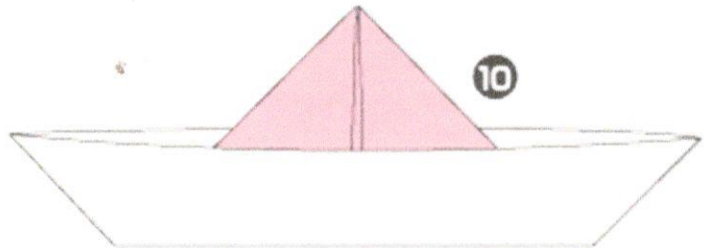

10

*Traditional
Diagram: Fumiaki Shingu

«САМОЛЕТ»

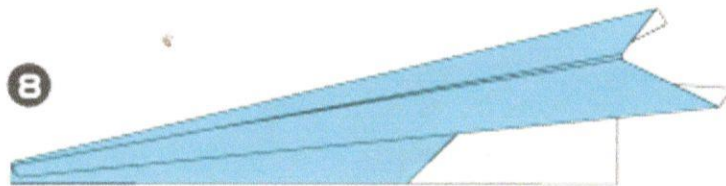
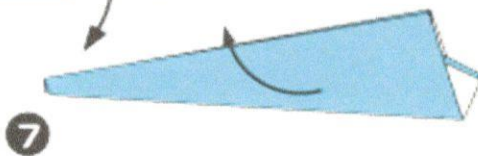
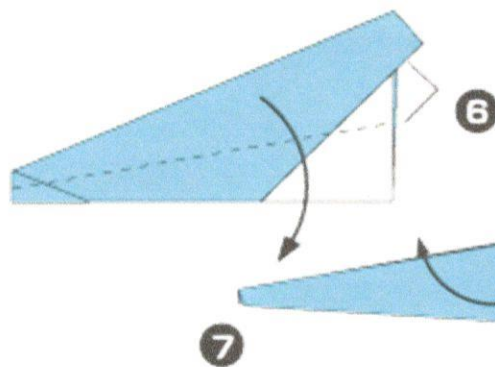
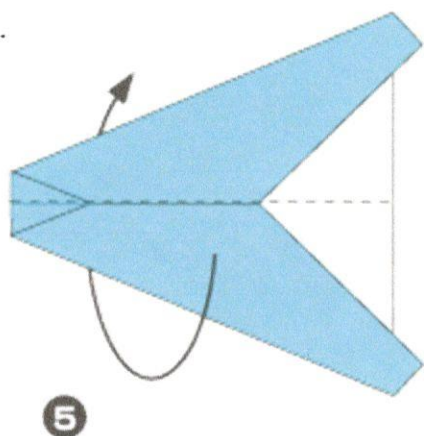
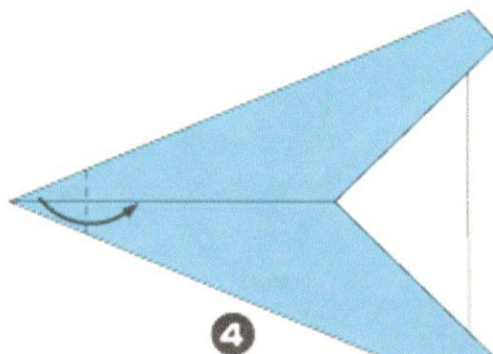
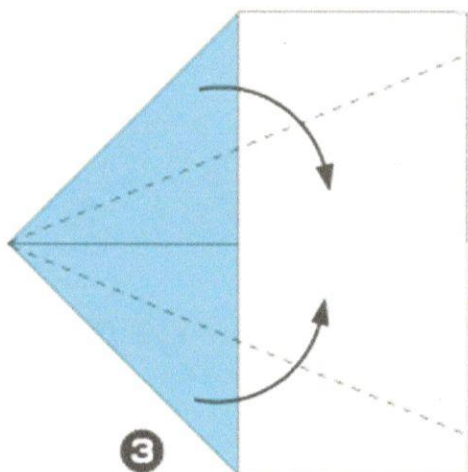
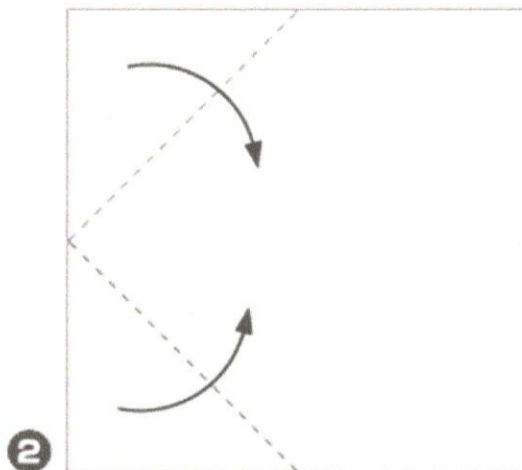
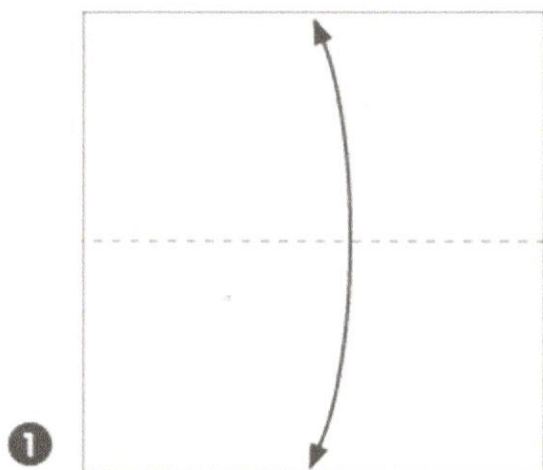

*Traditional
Diagram: Fumiaki Shingu