

КАРТОТЕКА СХЕМ ОРИГАМИ ДЛЯ СТАРШЕГО ДОШКОЛЬНОГО ВОЗРАСТА

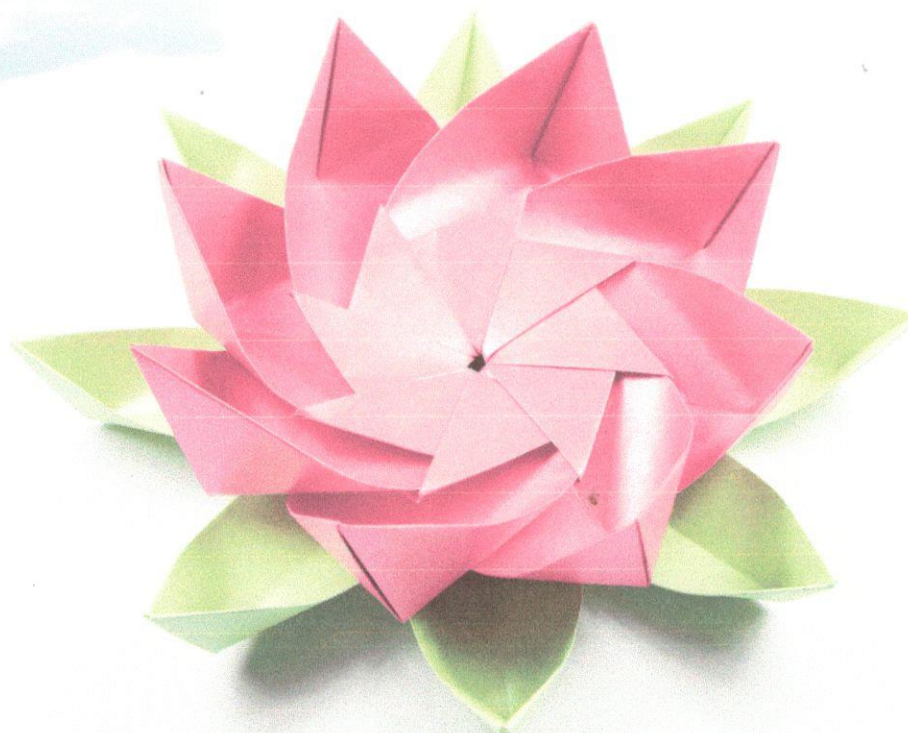

Автор-составитель:
Карканица Наталья Сергеевна,
воспитатель
МБДОУ г. Иркутска детского сада № 28



Оригами «ЛОШАДЬ»

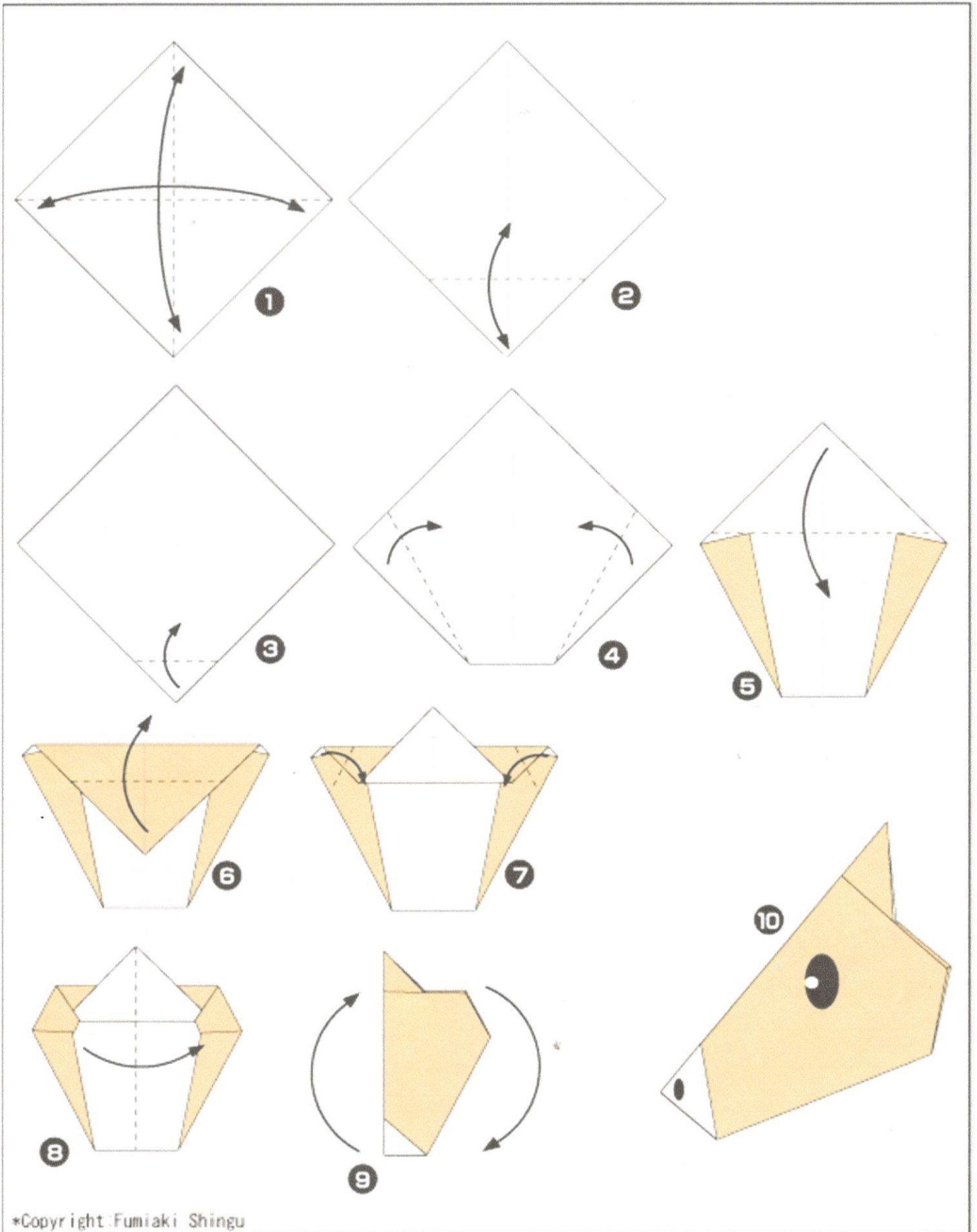

ОРИГАМИ «ЦВЕТОК»

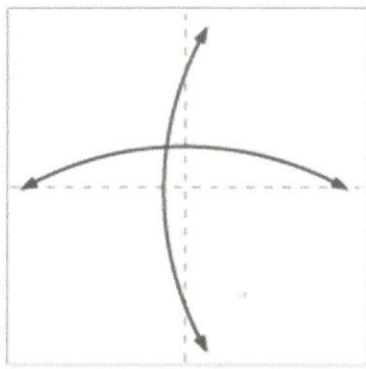

1

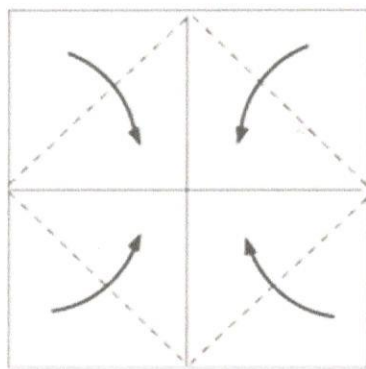

2

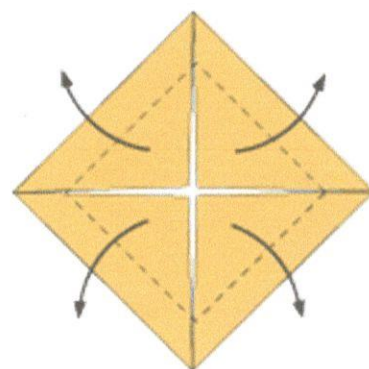

3

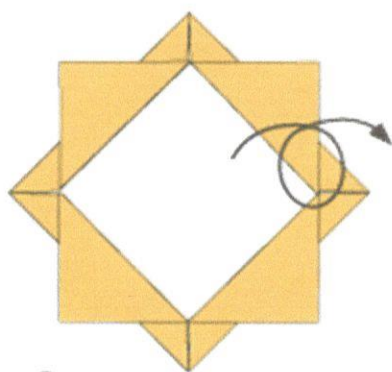

4

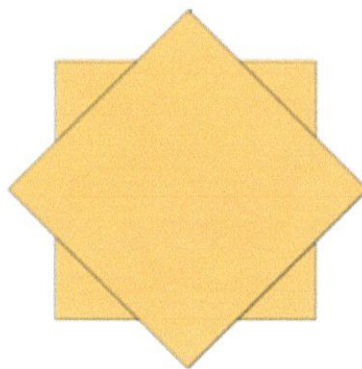

5

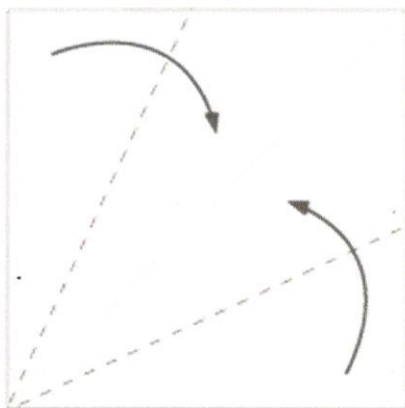

1

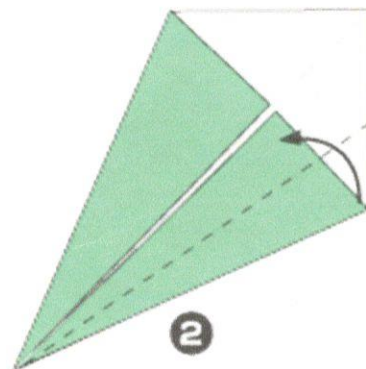

2

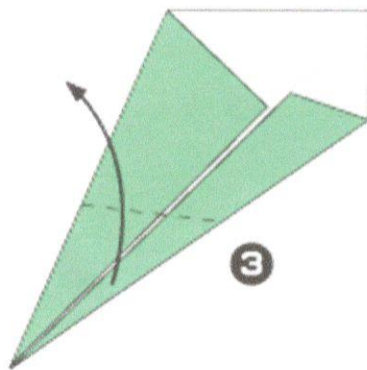

3

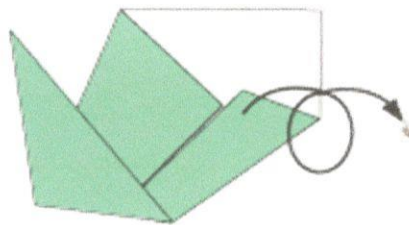

4

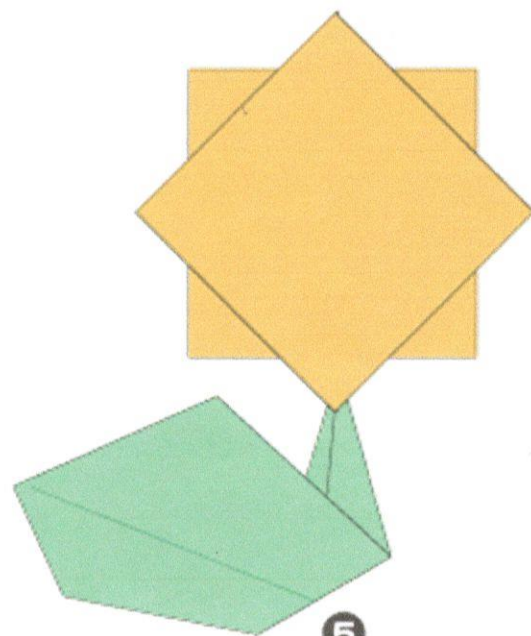

5

«СЕРДЦЕ»

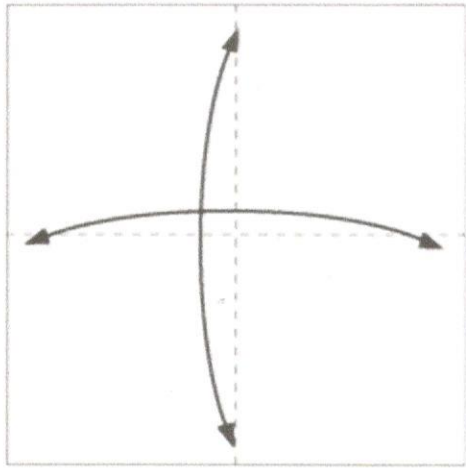

1

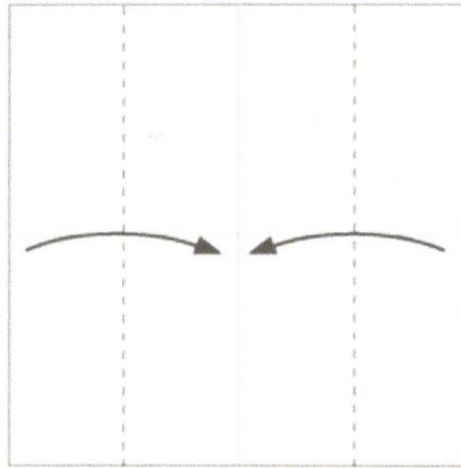

2

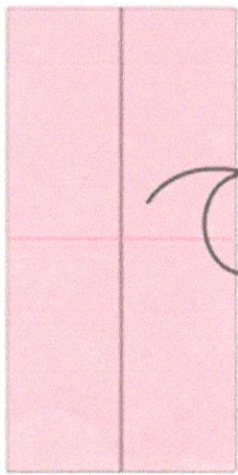

3

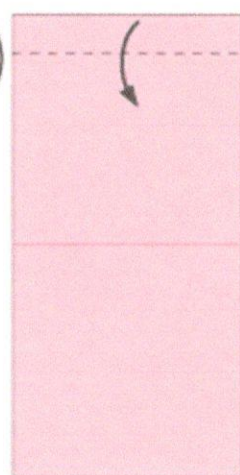
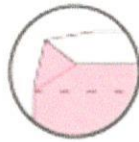

4

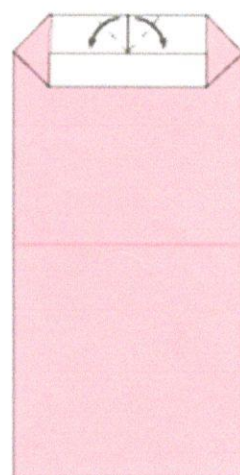

5

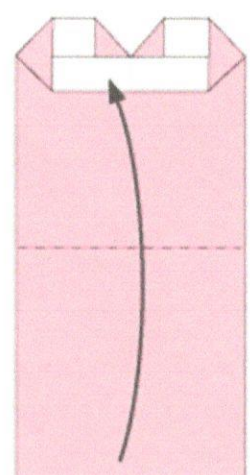

6

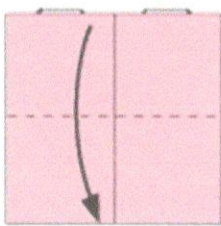

7

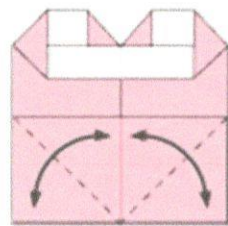

8

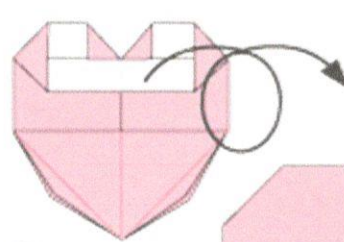

9

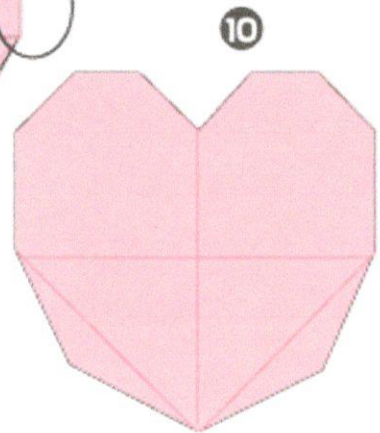

10

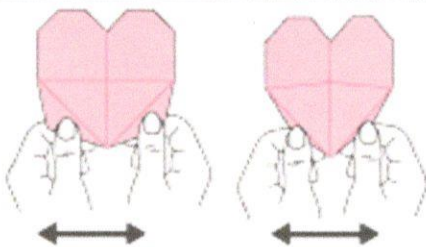

«ПАРУСНИК»

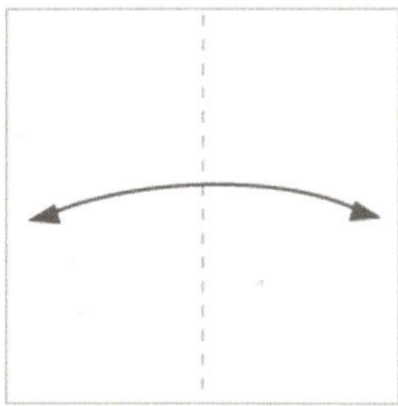

1

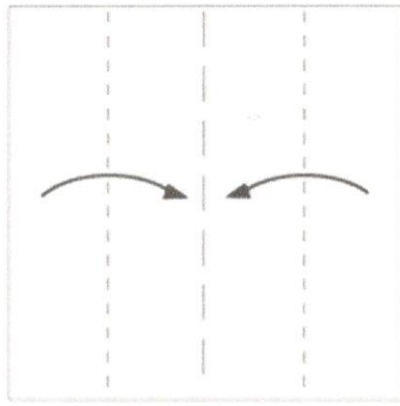

2

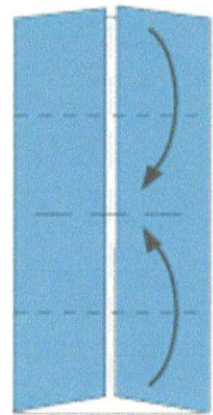

3

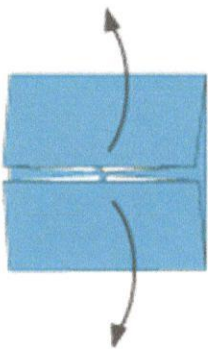

4

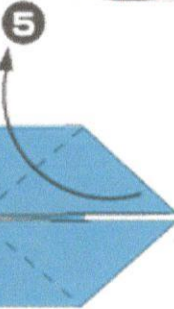
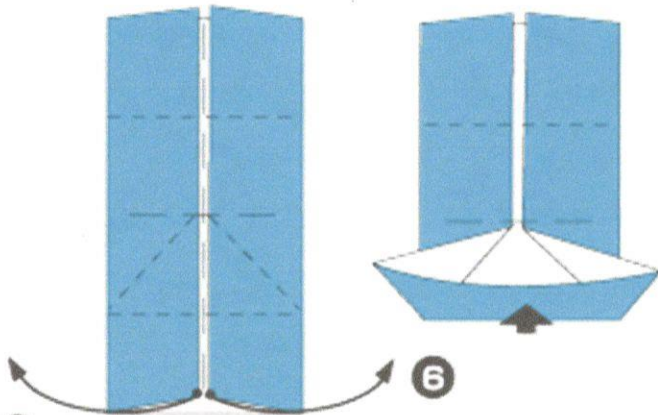

5

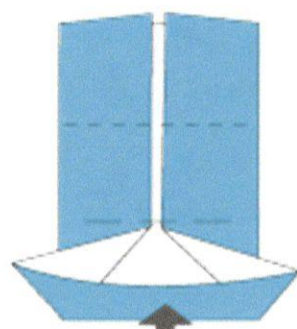

6

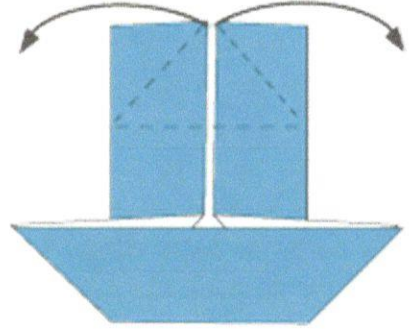

7

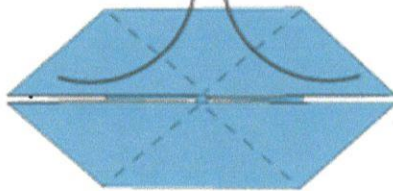

8

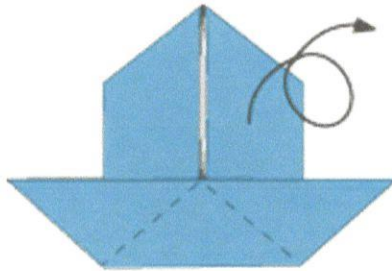

9

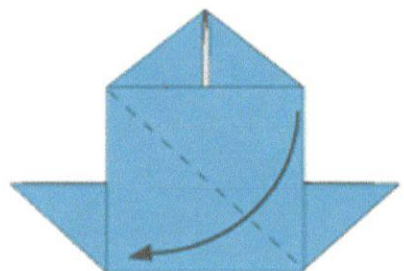

10

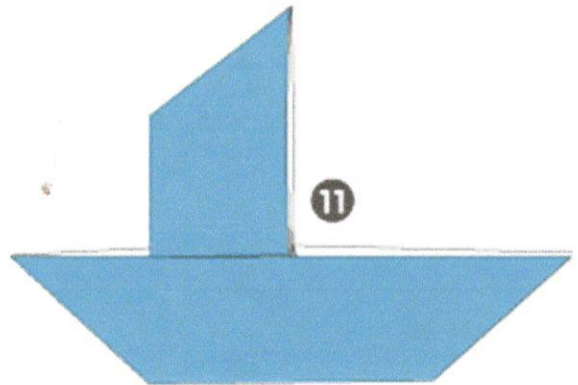
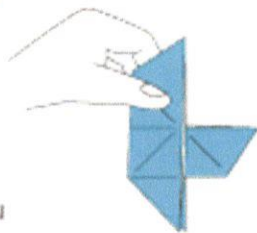
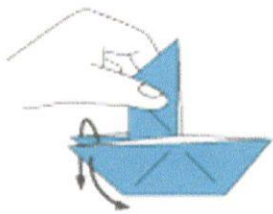

11

*Traditional
Diagram: Fumiaki Shingu

«ЗВЕЗДА»

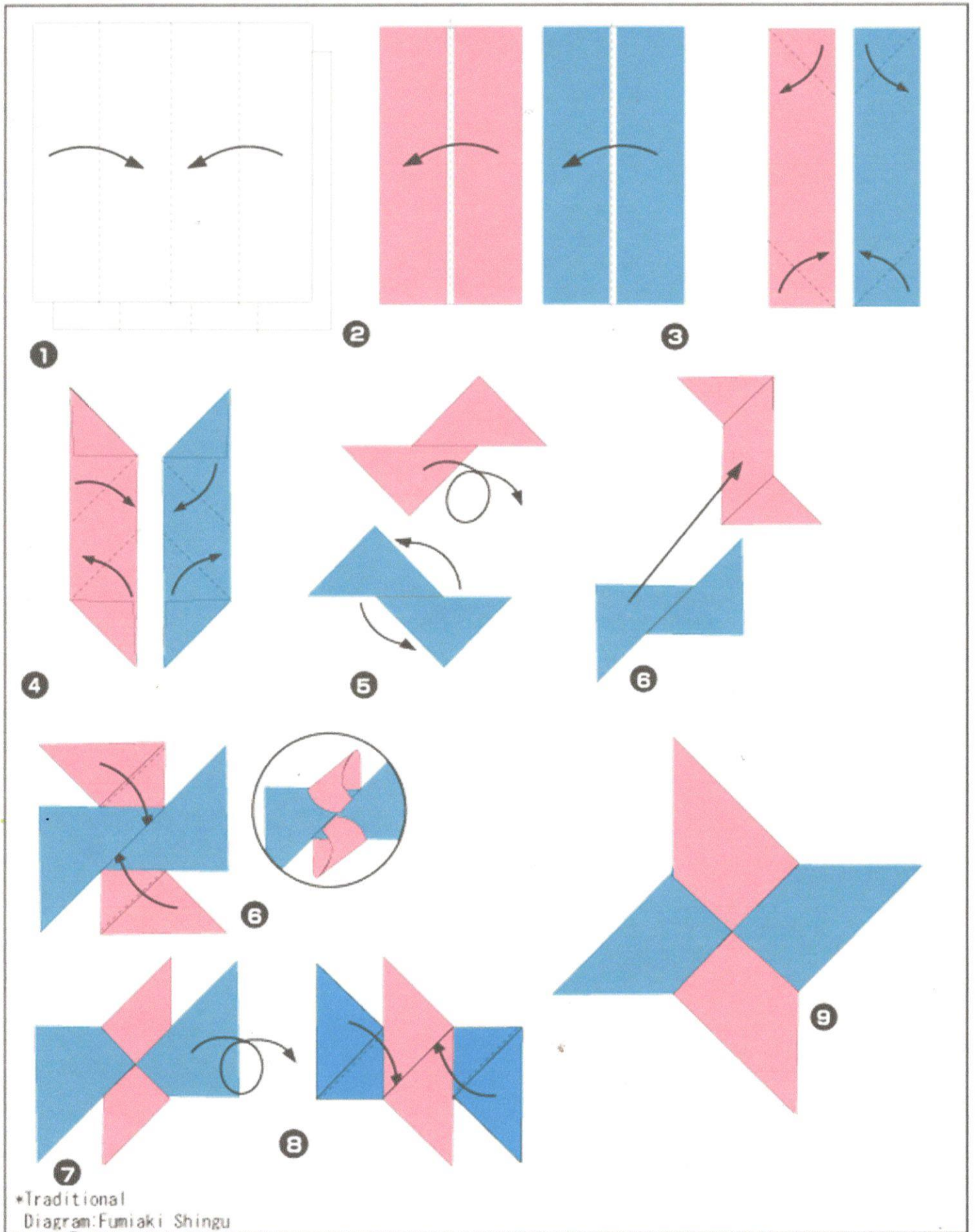

«МЫШЬ»

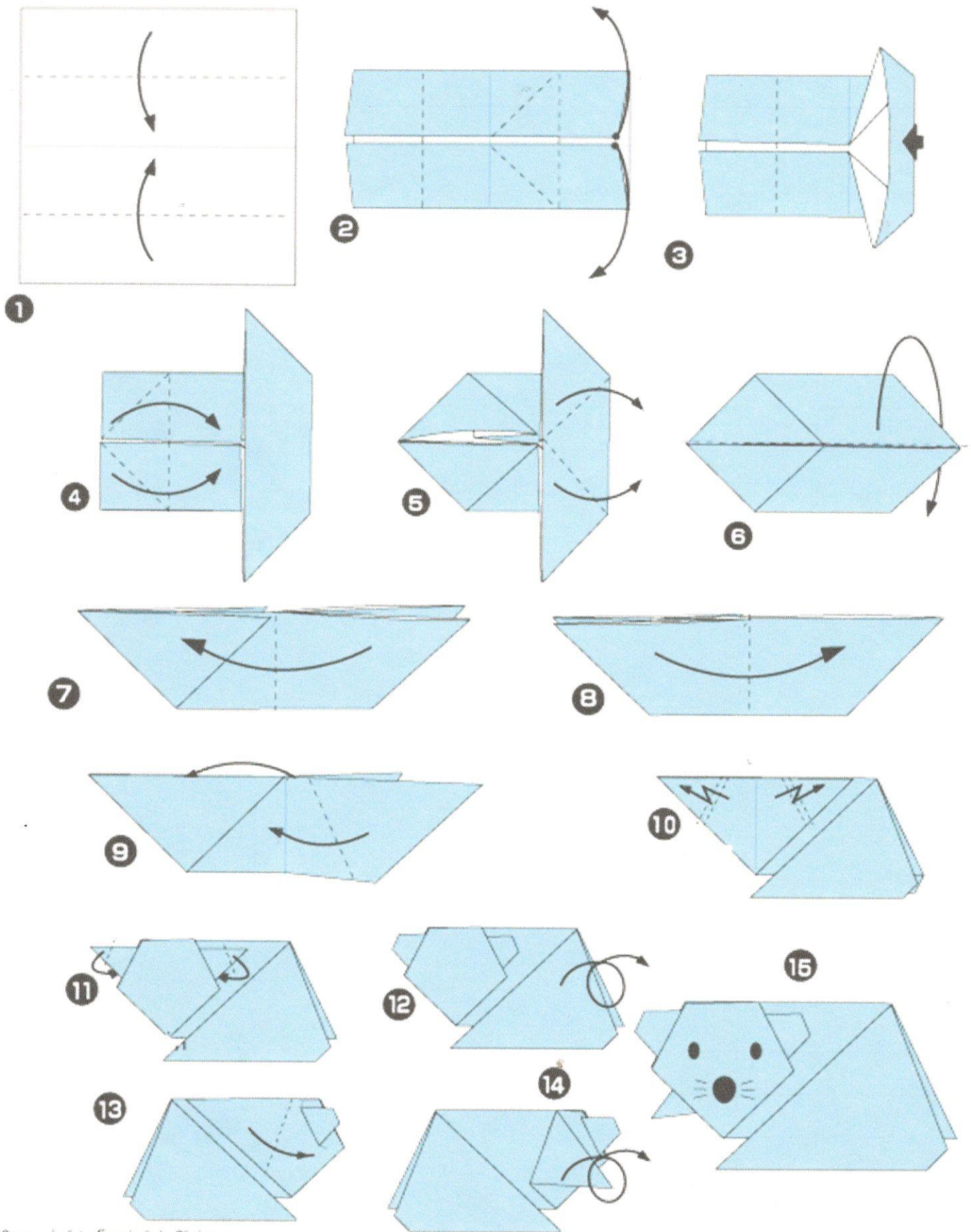

«СТРАУС»

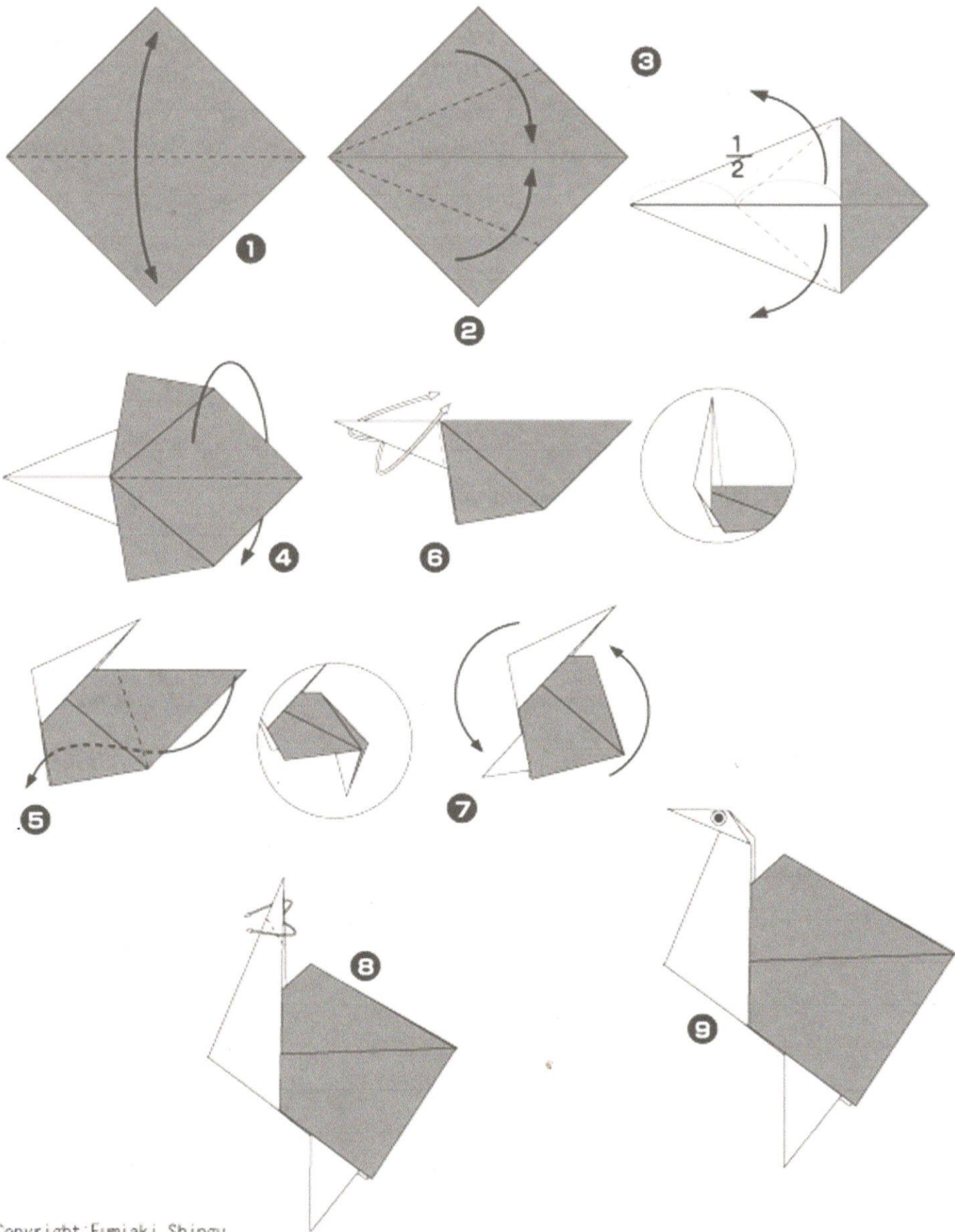

«МЫШЬ»

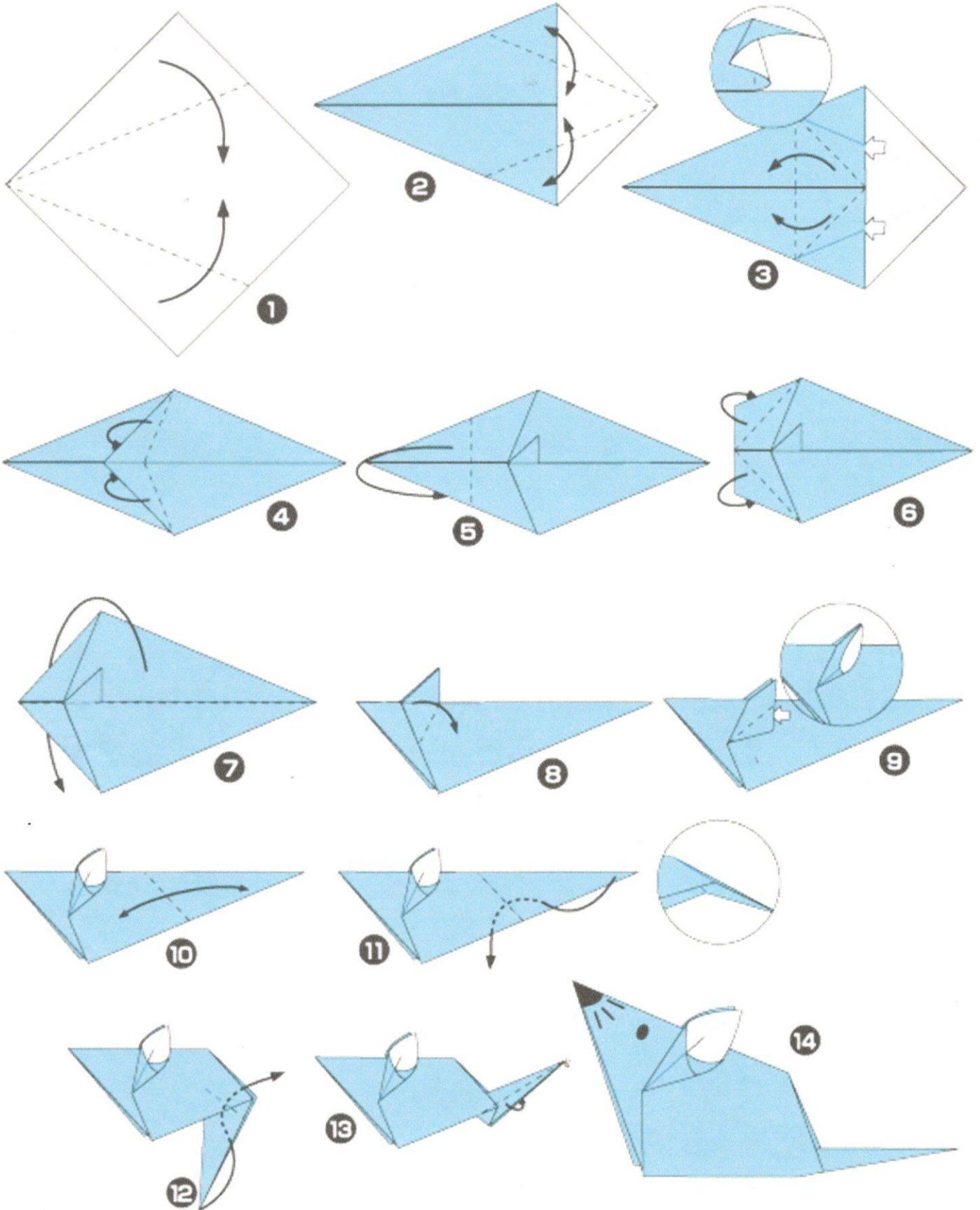

«TAKCA»

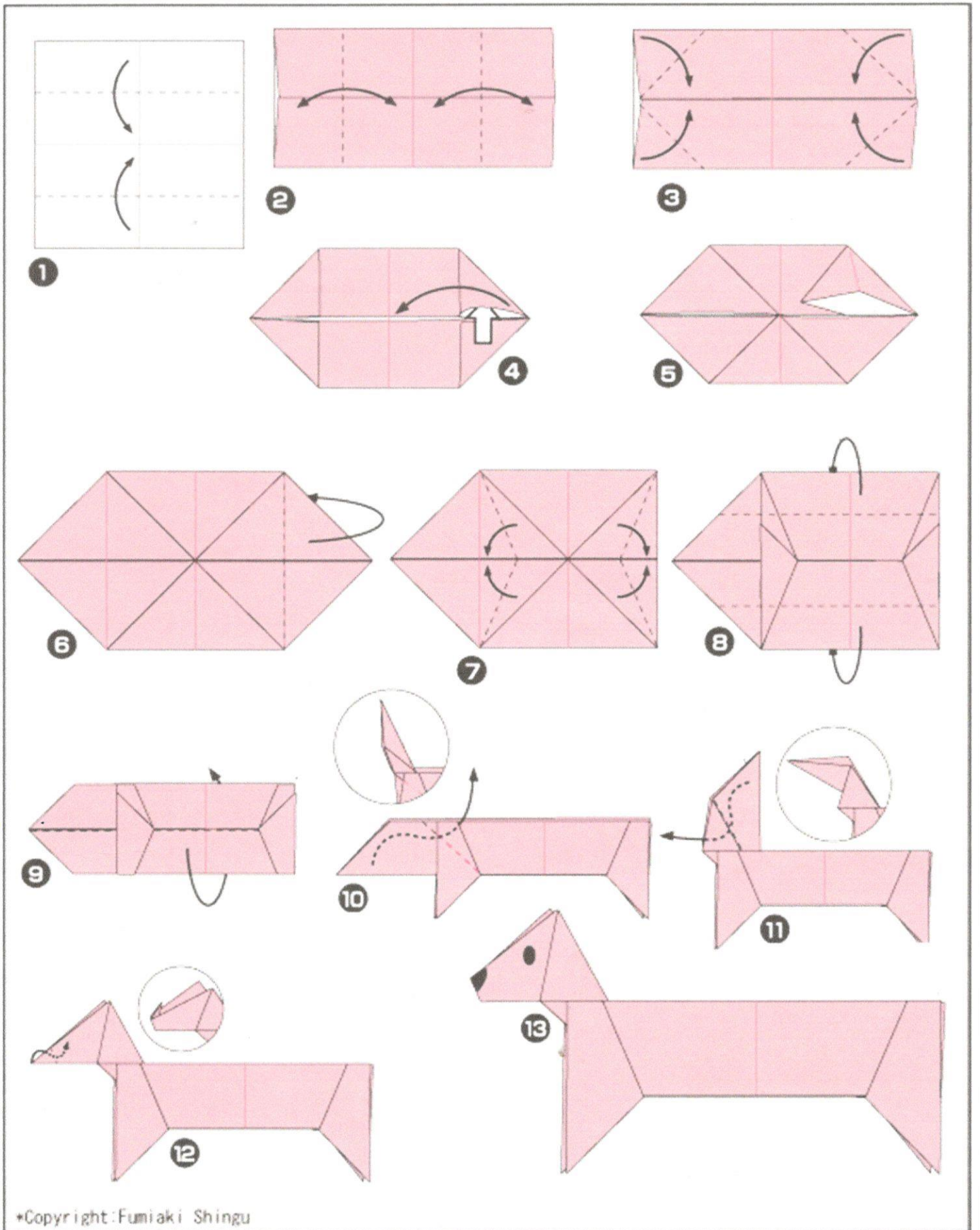

«ЗМЕЯ»

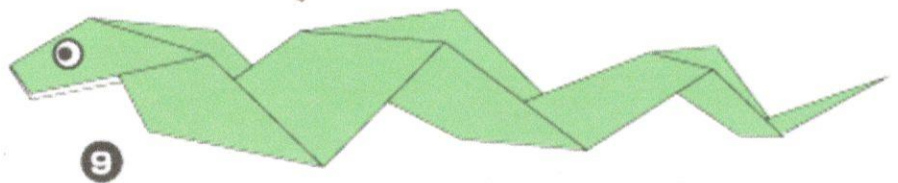
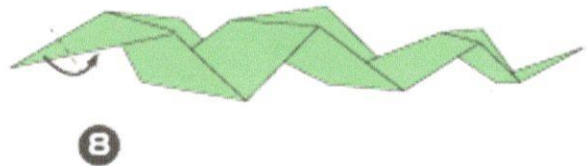
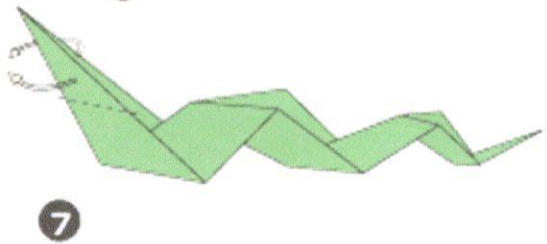
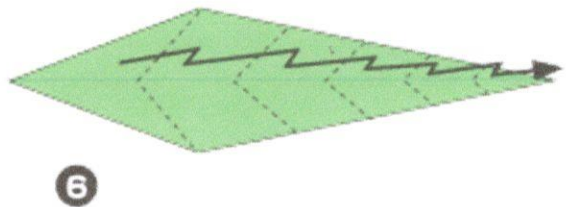
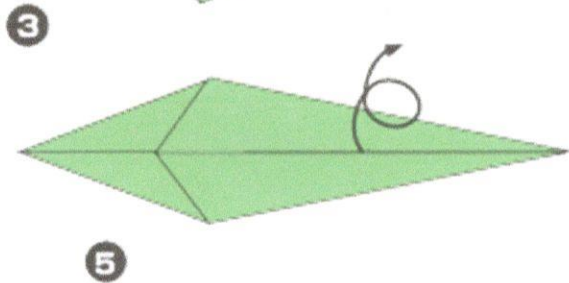
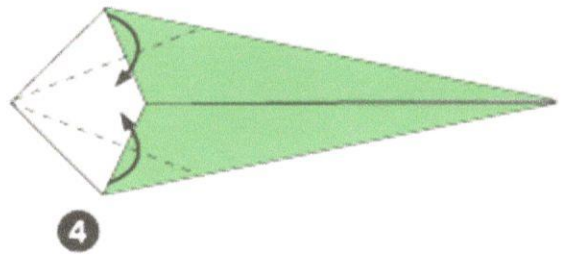
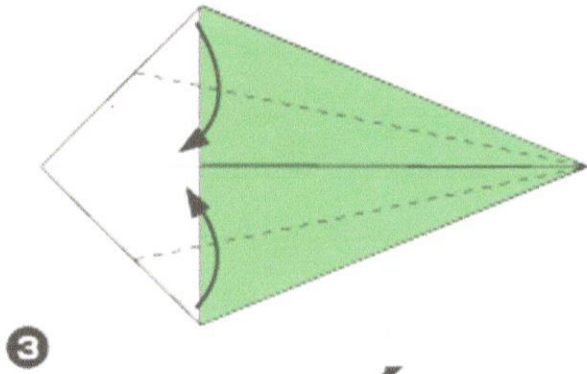
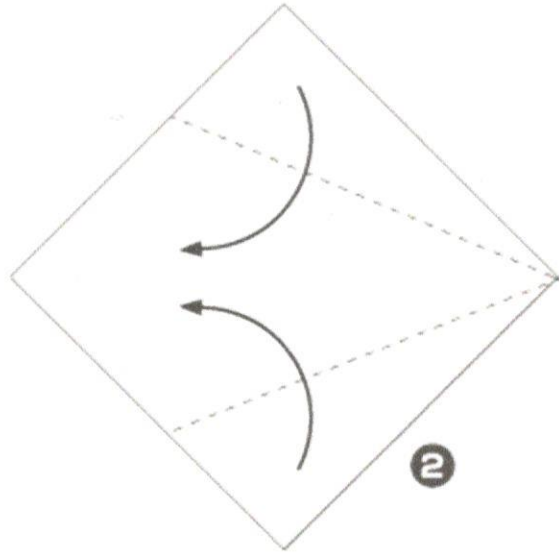
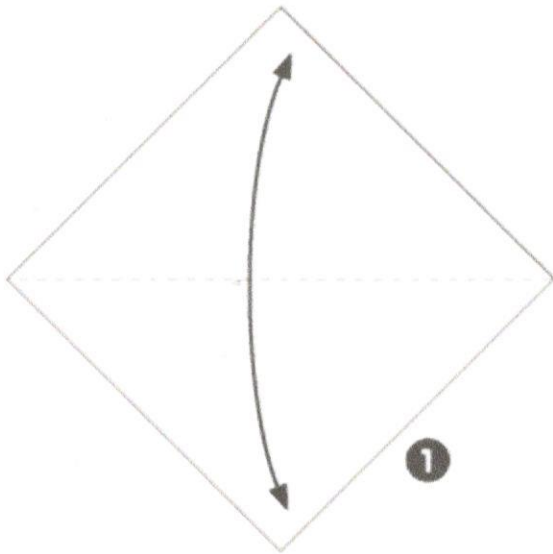

ОРИГАМИ «КРАБ»

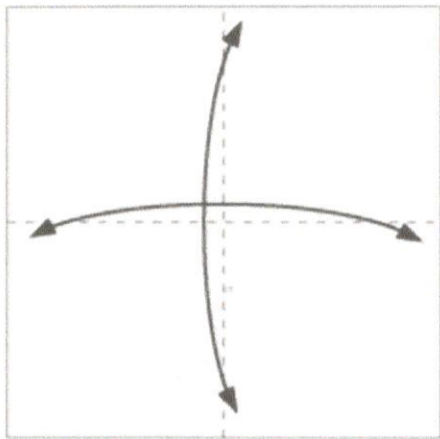

1

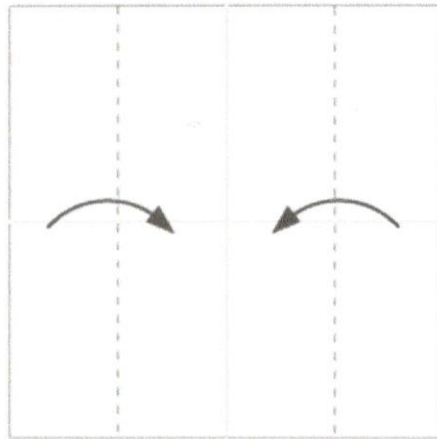

2

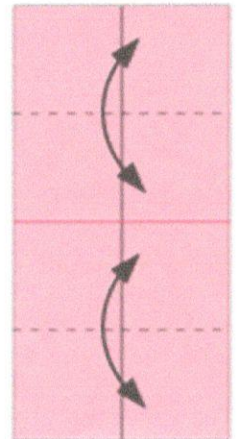

3

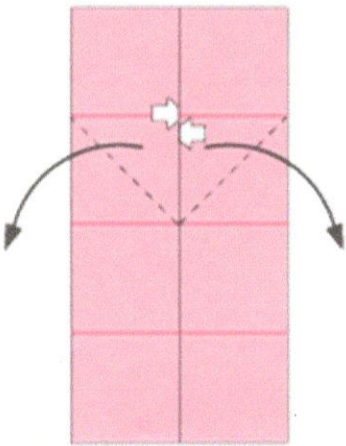

4

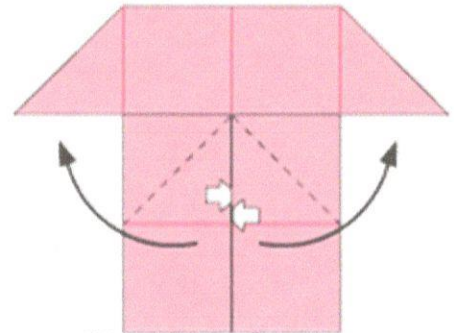
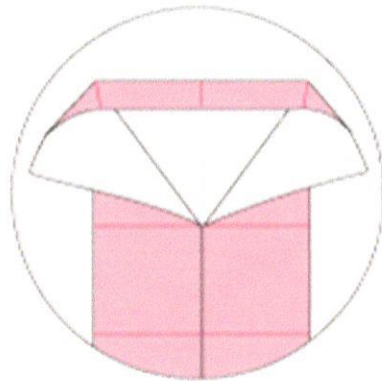

5

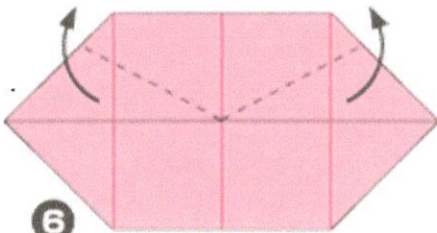

6

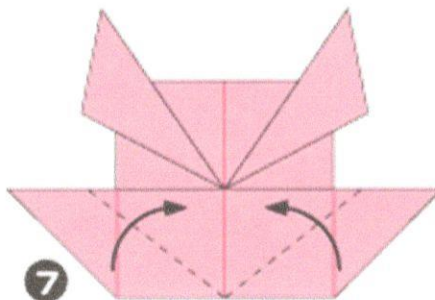

7

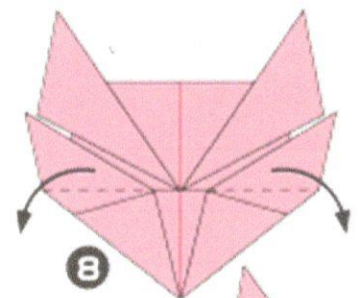

8

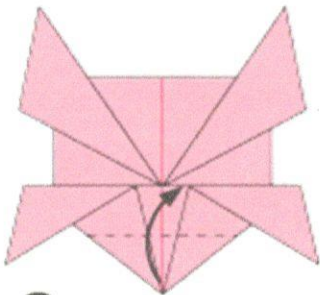

9

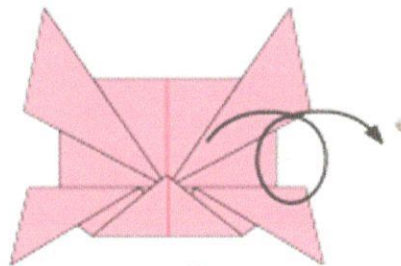

10

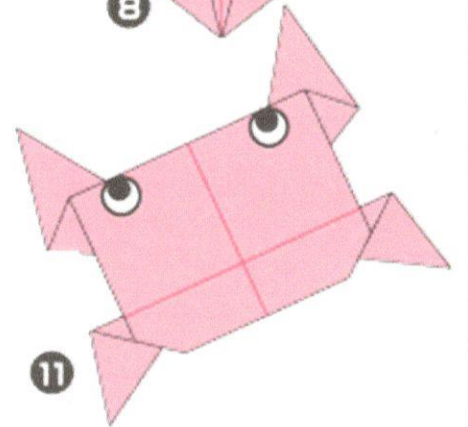

11

ОРИГАМИ «КАСАТКА»

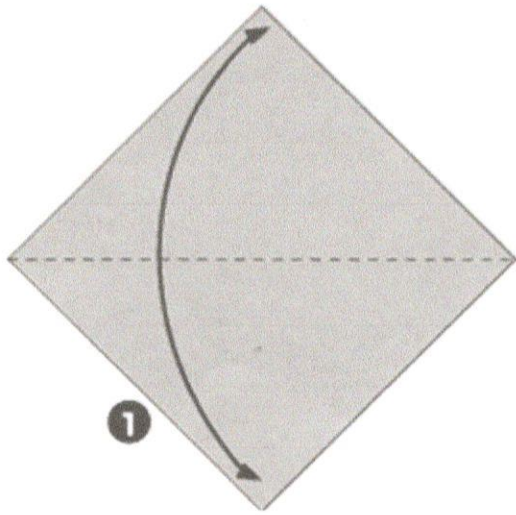

1

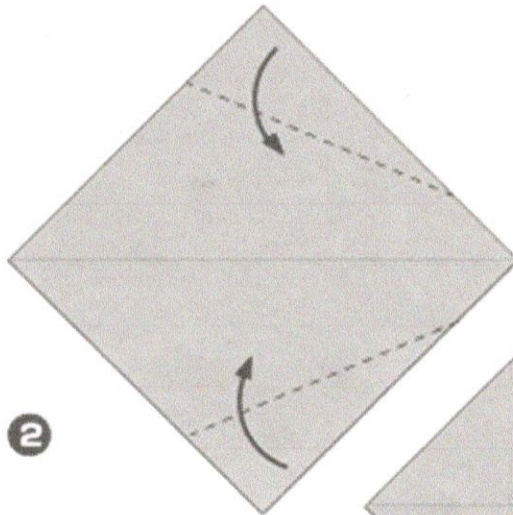

2

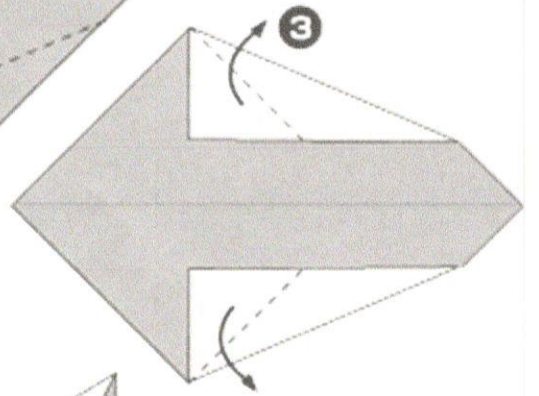

3

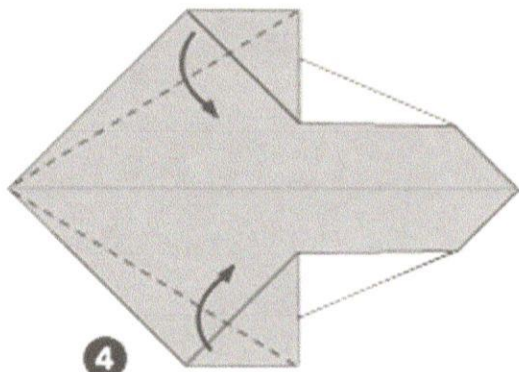

4

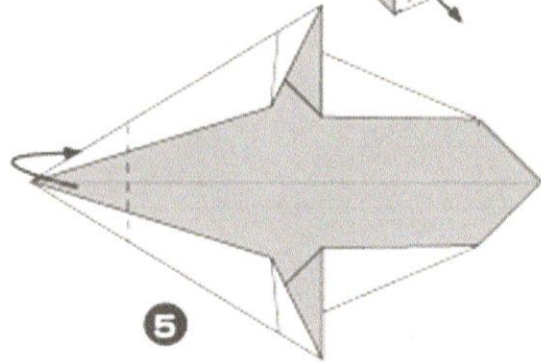

5

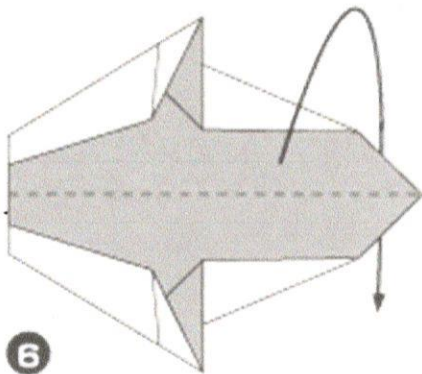

6

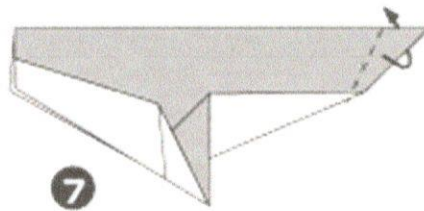

7

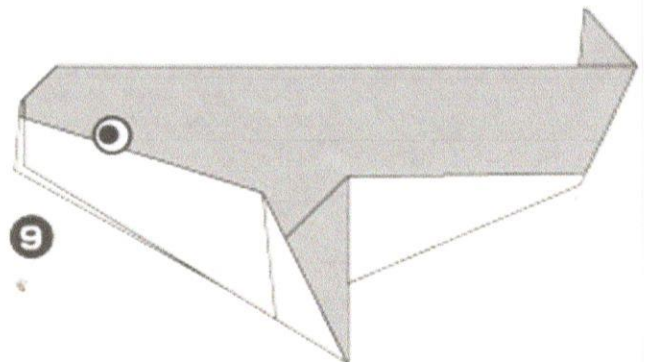

9

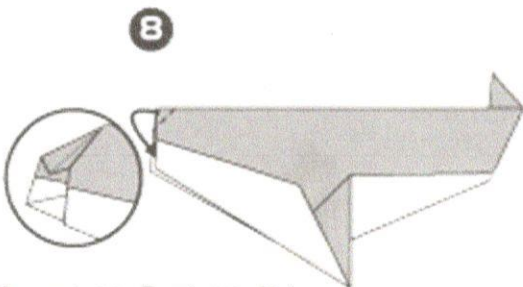

8

«ГРИБ»

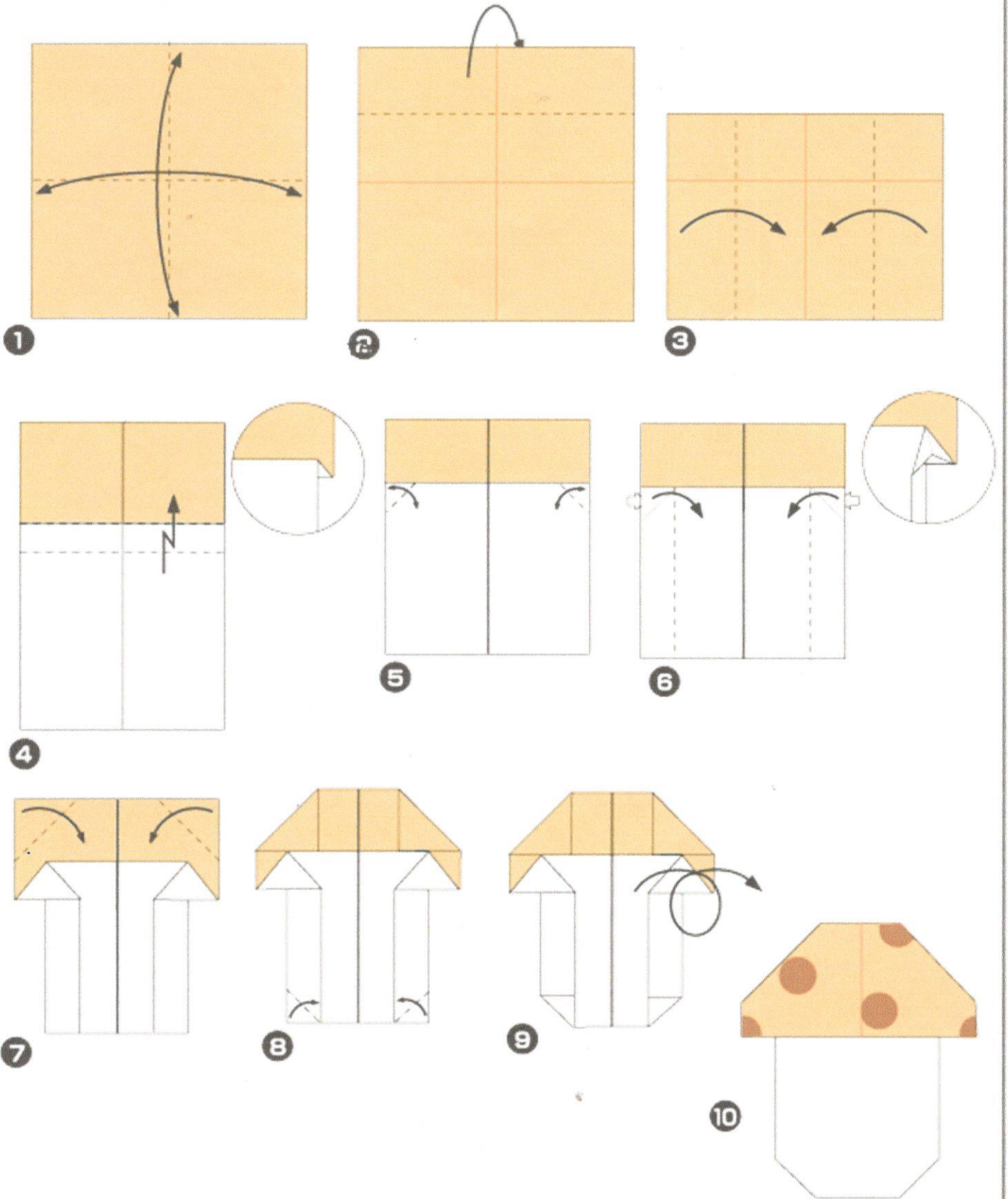

«ВЕТРЯНАЯ МЕЛЬНИЦА»

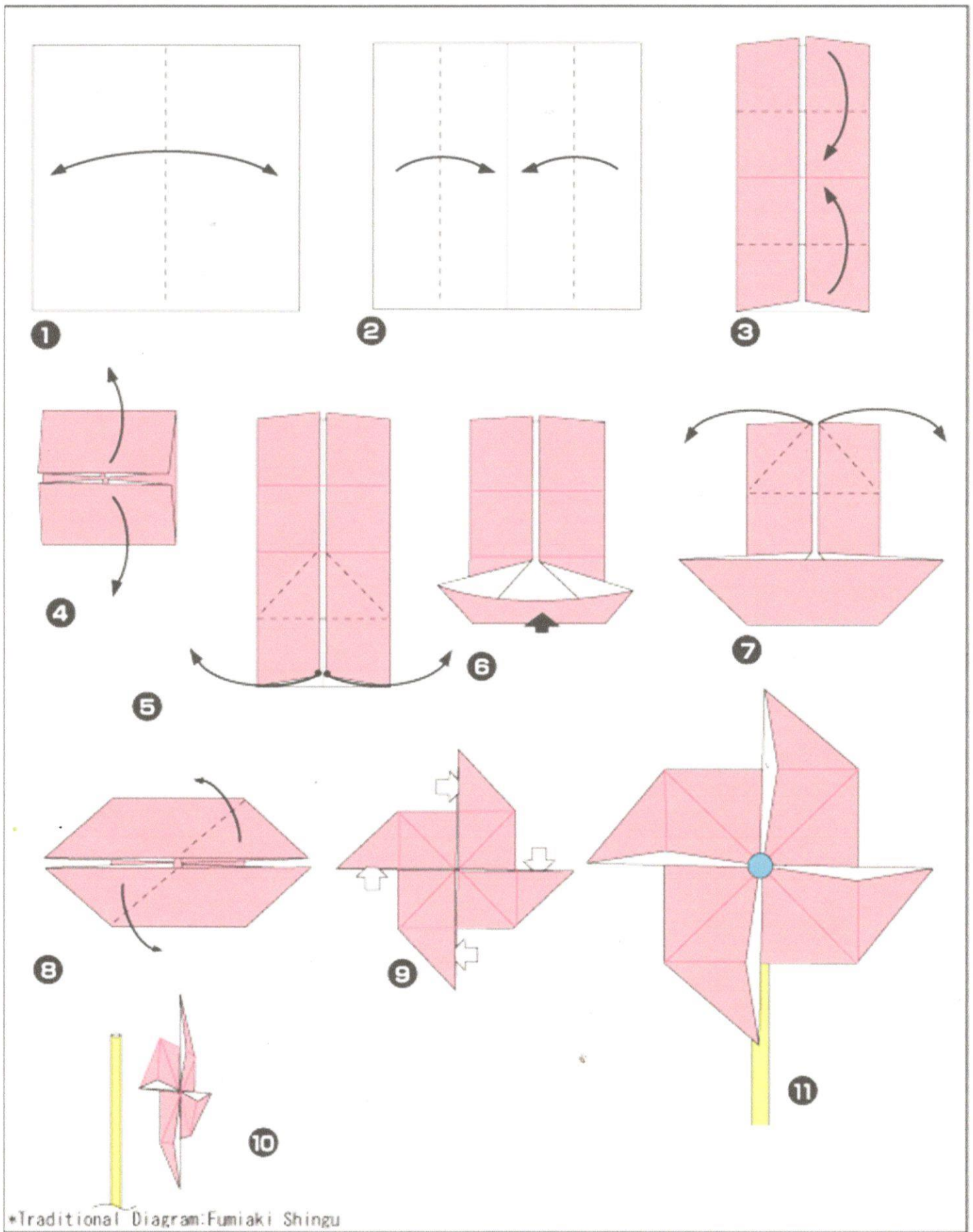

«ЯБЛОКО»

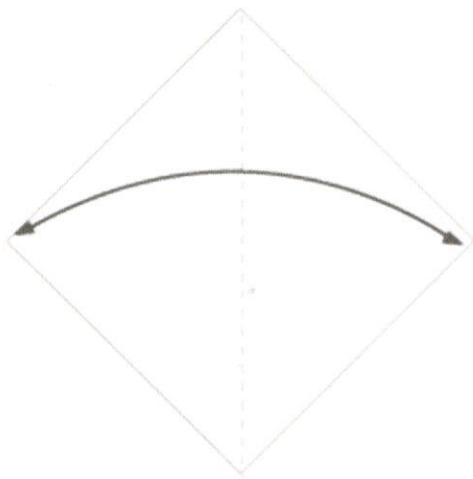

1

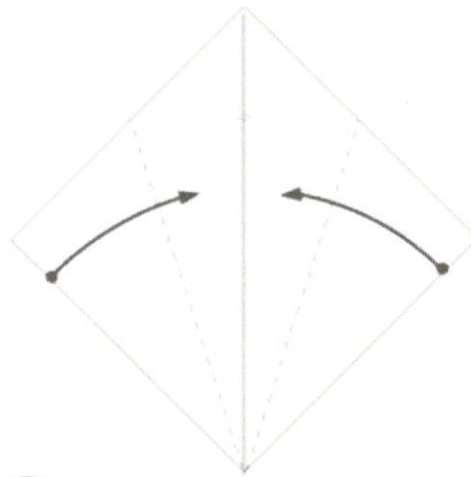

2

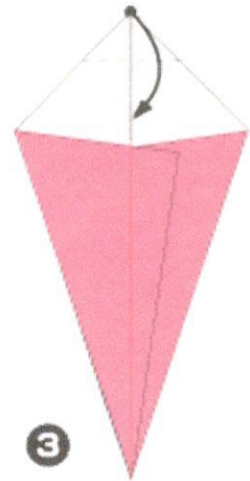

3

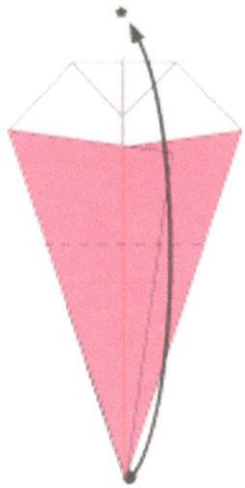

4

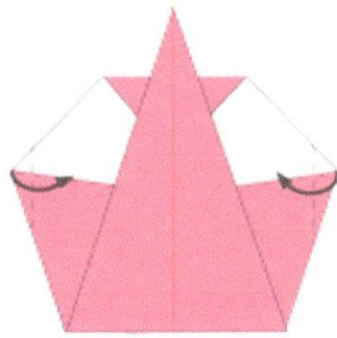

5

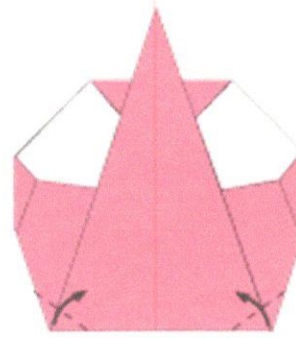

6

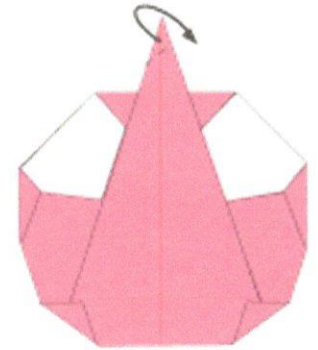

7

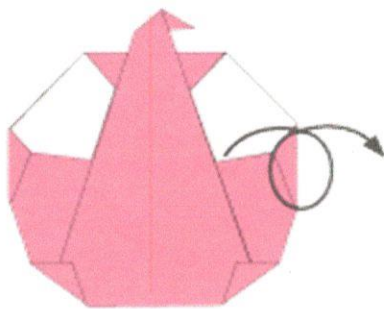

8

9 Finished

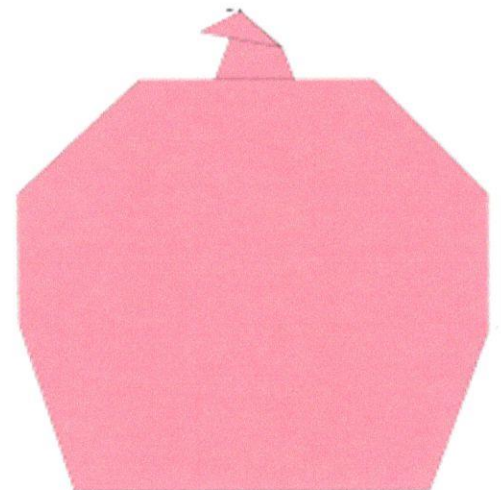

«ТАПКИ»

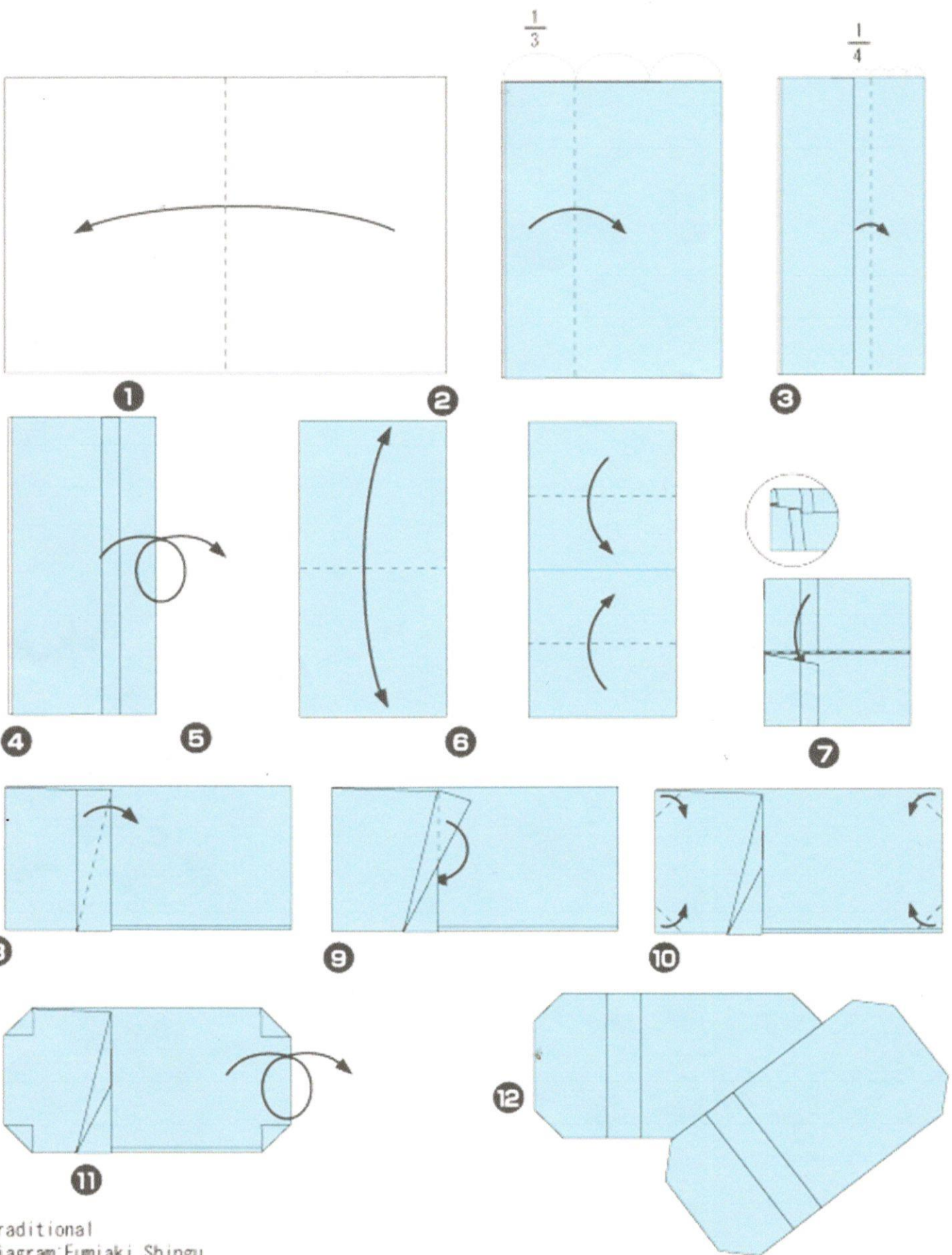

*Traditional
Diagram: Fumiaki Shingu

«УТКА»

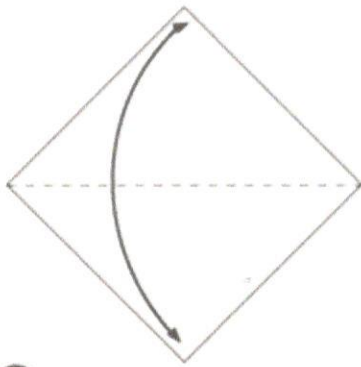

1

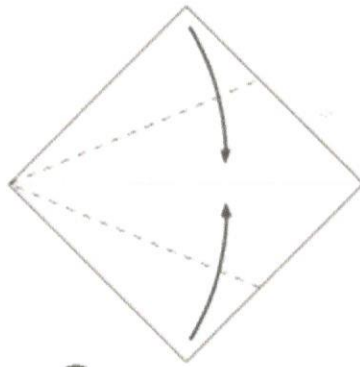

2

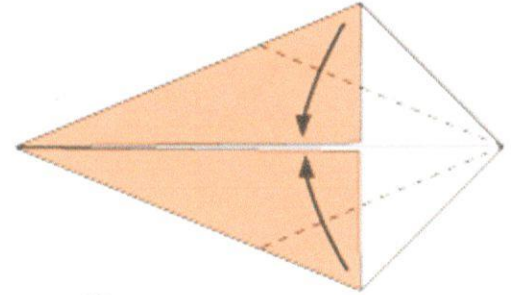

3

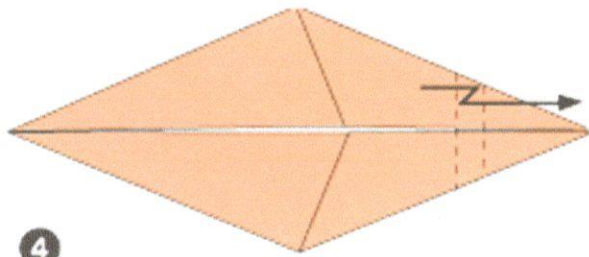

4

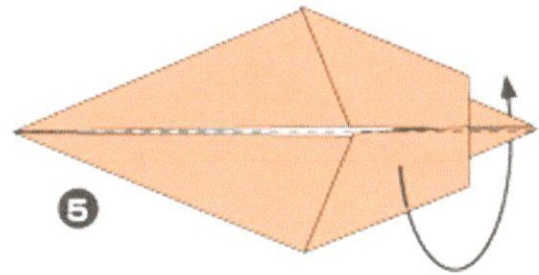

5

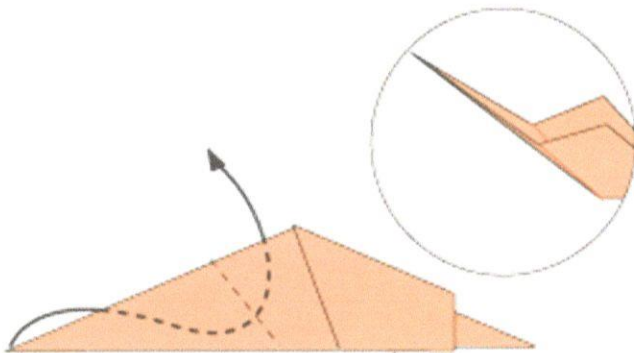

6

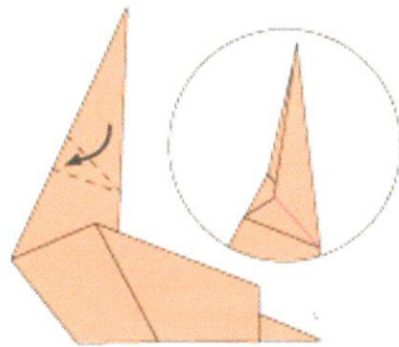

7

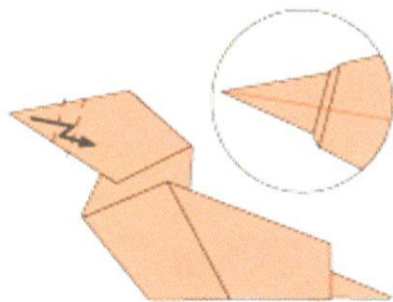

8

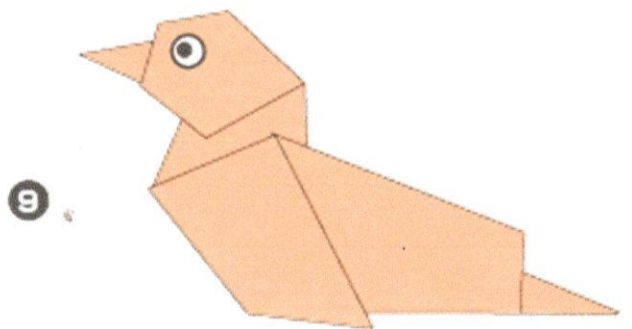

9

«ИСТРЕБИТЕЛЬ»

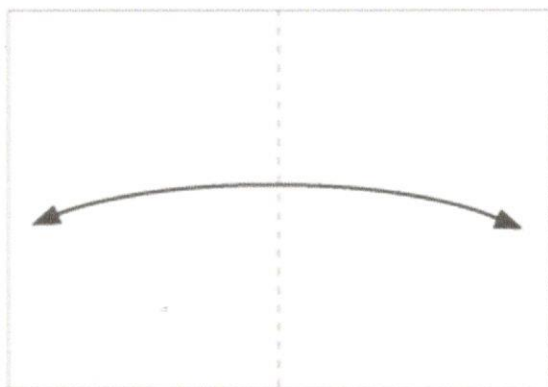

1

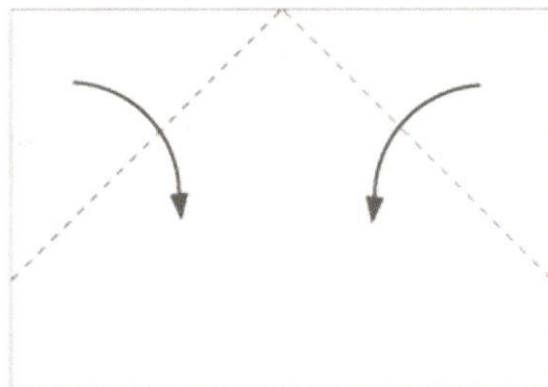

2

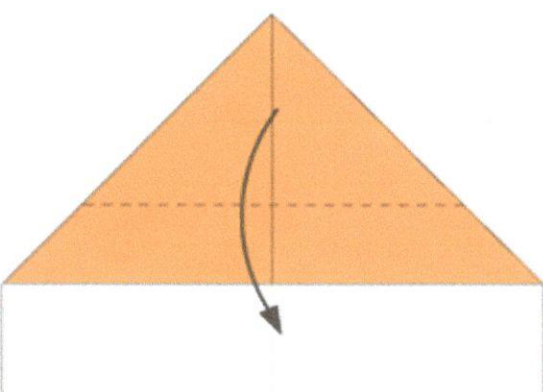

3

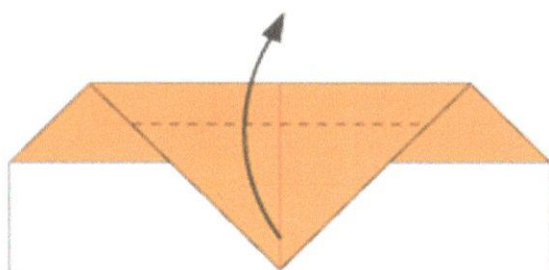

4

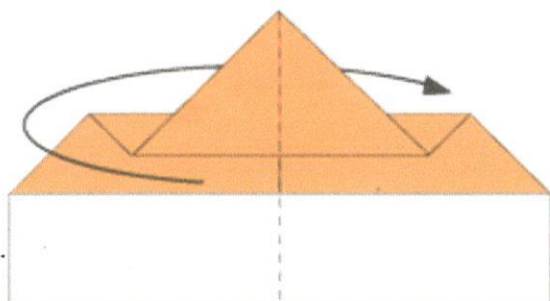

5

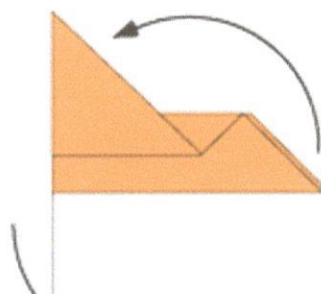

6

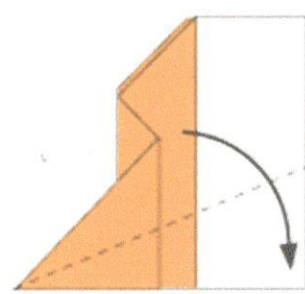

7

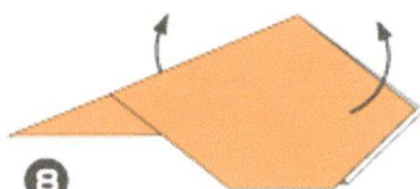

8

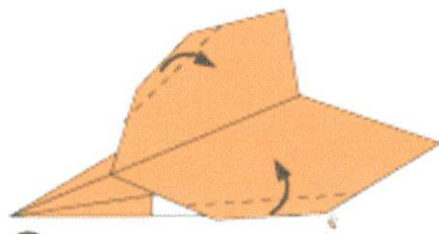

9

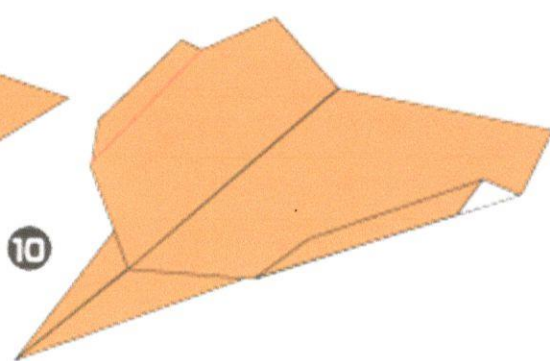

10

*Arrangement of Traditional
Diagram: Fumiaki Shingu

«КОНФЕТА»

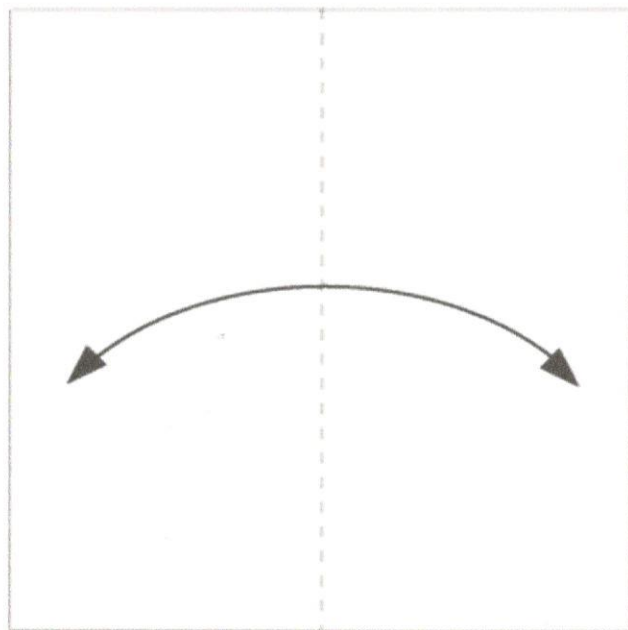

1

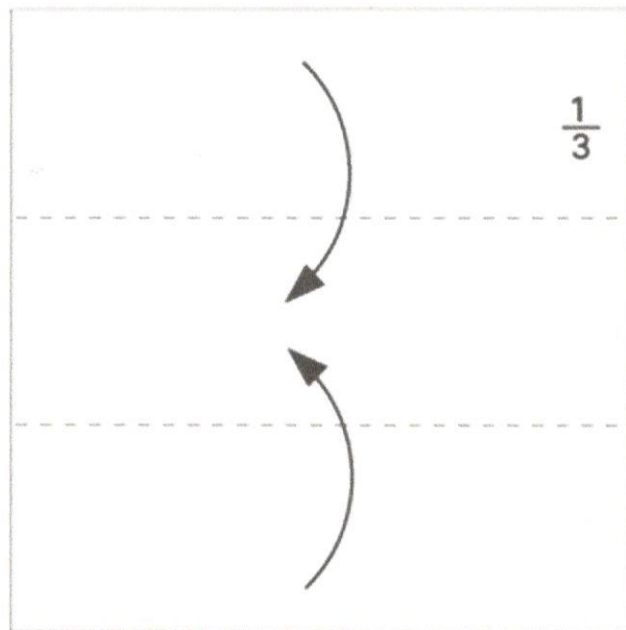

2

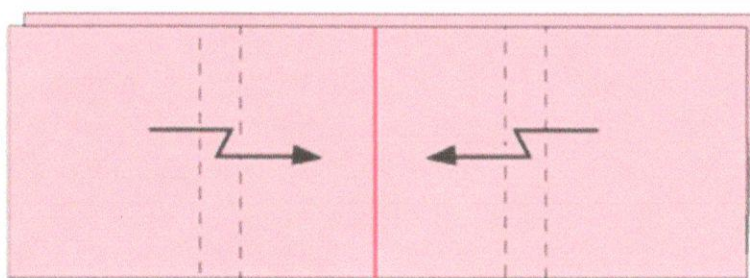

3

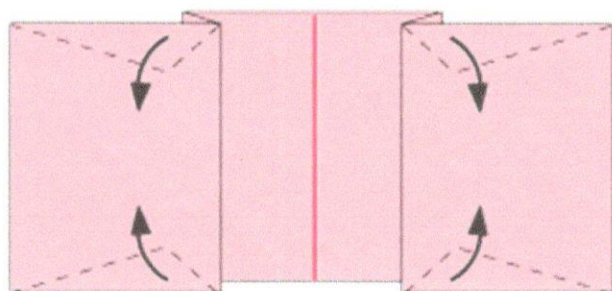

4

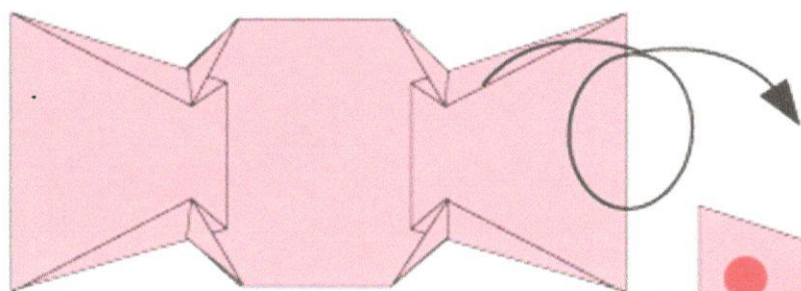

5

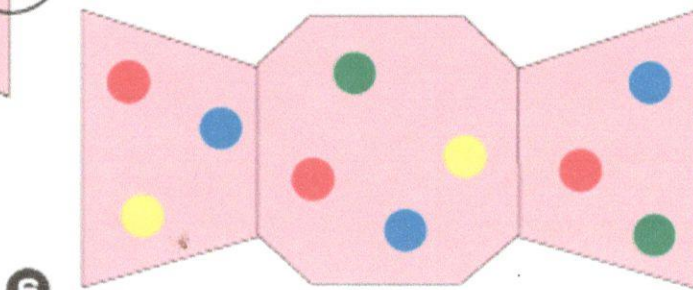

6

ОРИГАМИ «РЫБА»

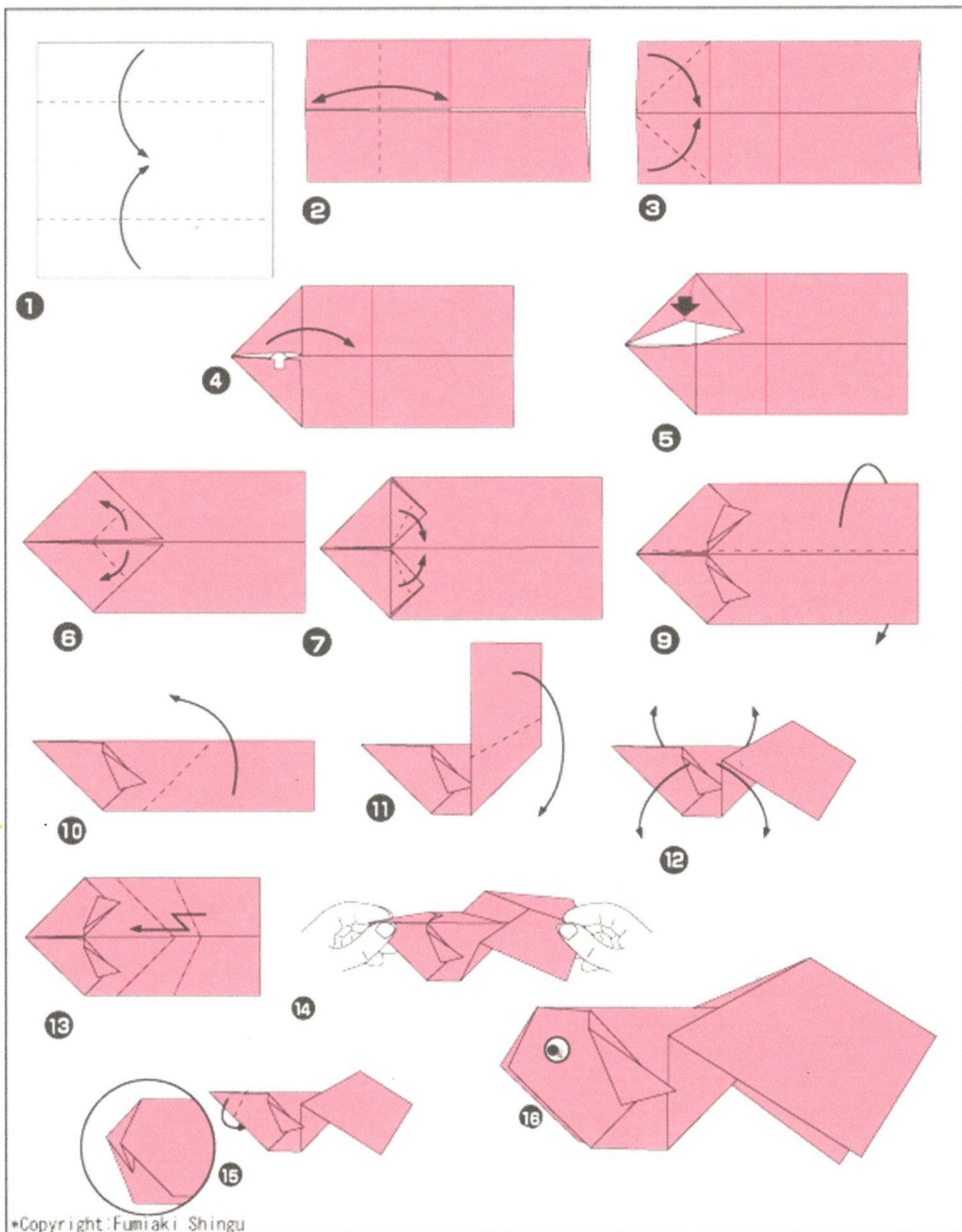

«БОРОНА»

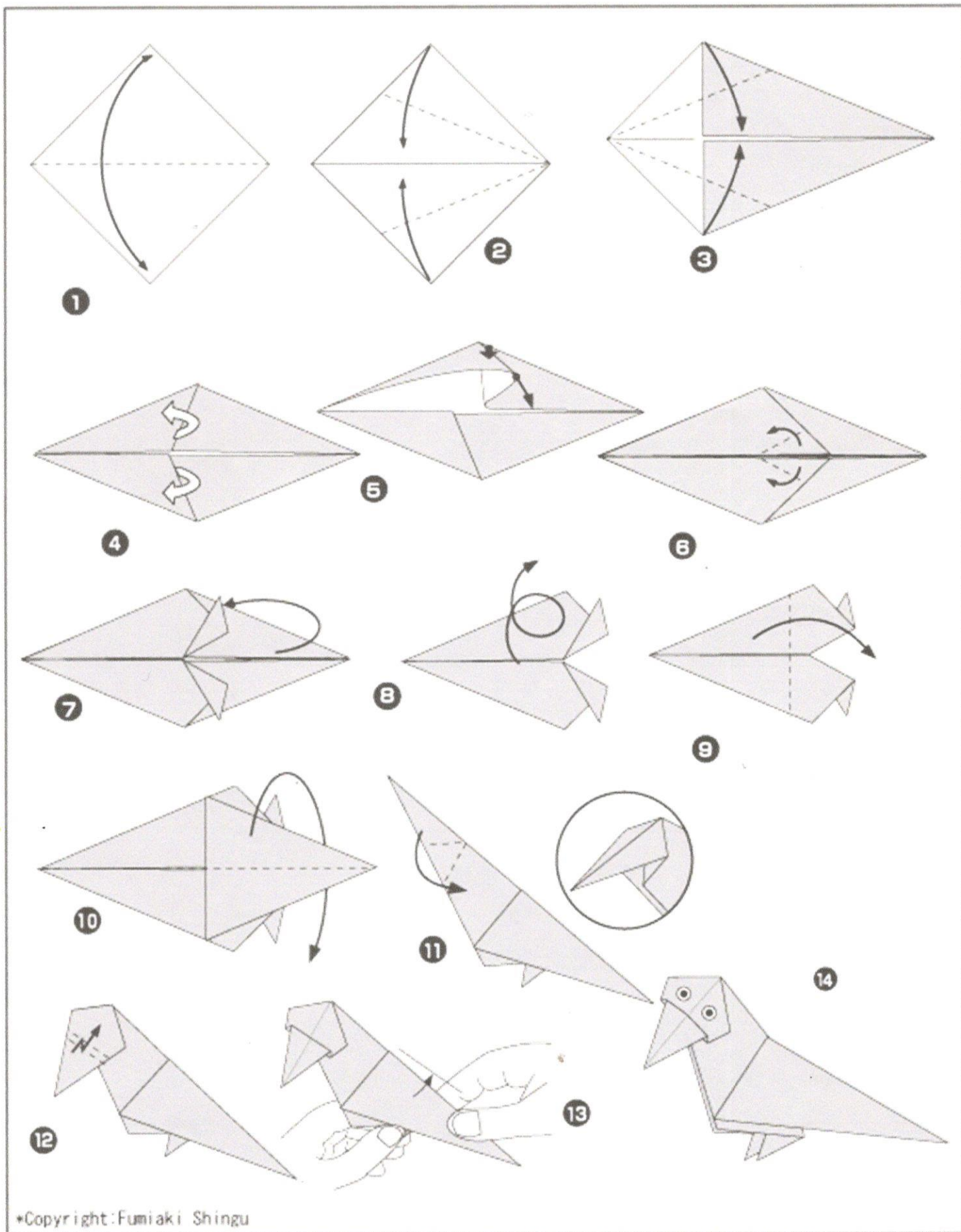

«ЛОДКА»

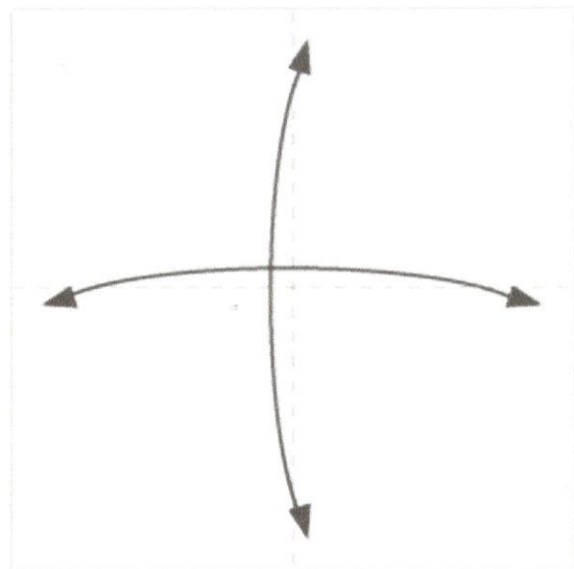

1

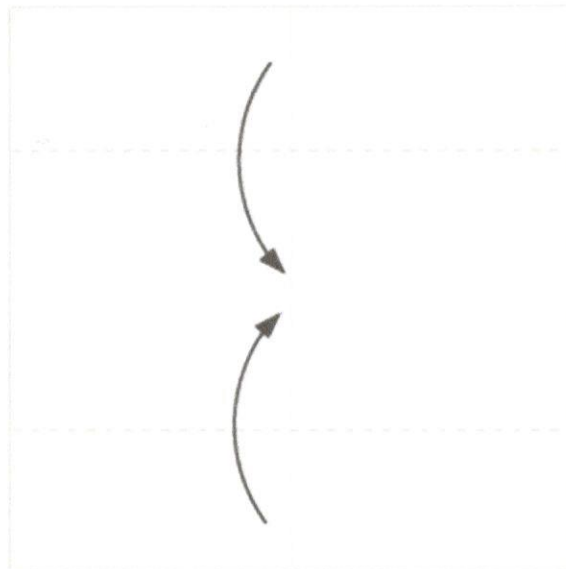

2

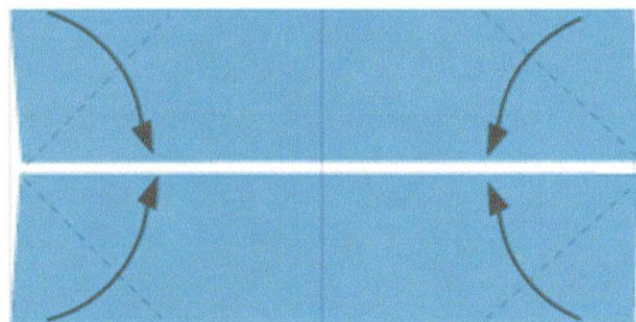

3

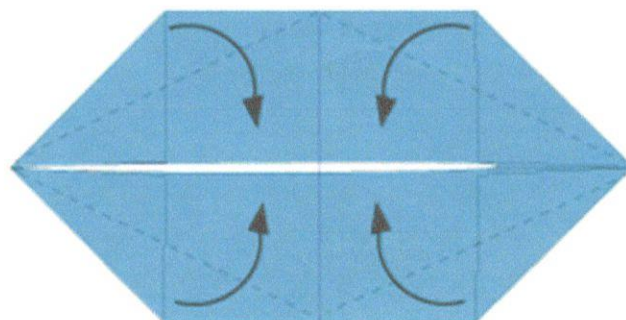

4

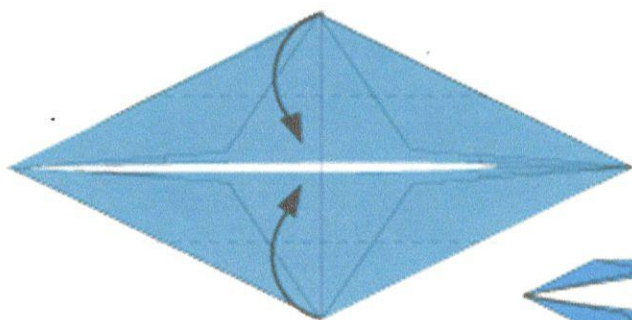

5

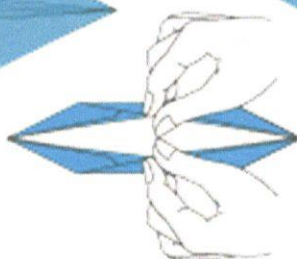

6

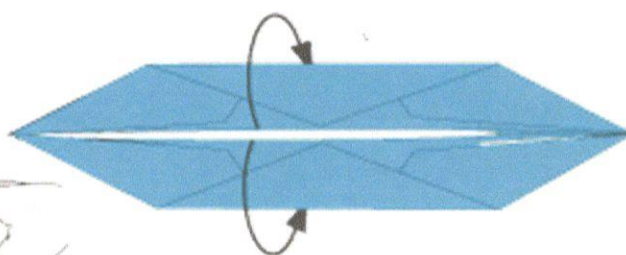

7

*Traditional
Diagram: Fumiaki Shingu

«ВОЗДУШНЫЙ ШАР»

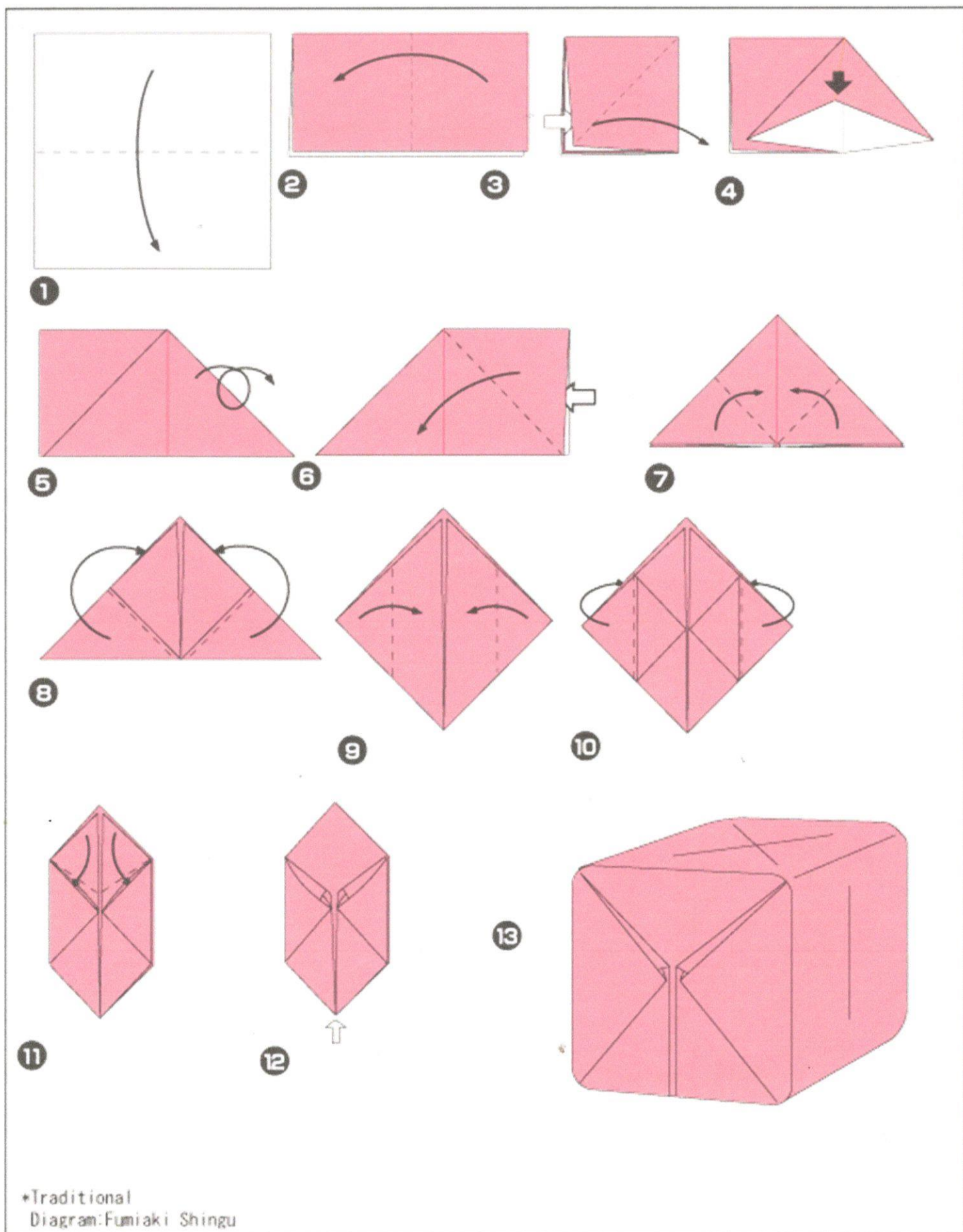

*Traditional
Diagram: Fumiaki Shingu

«ЖУРАВЛИК»

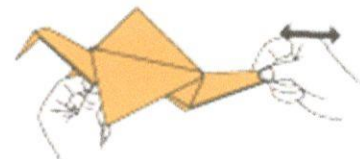
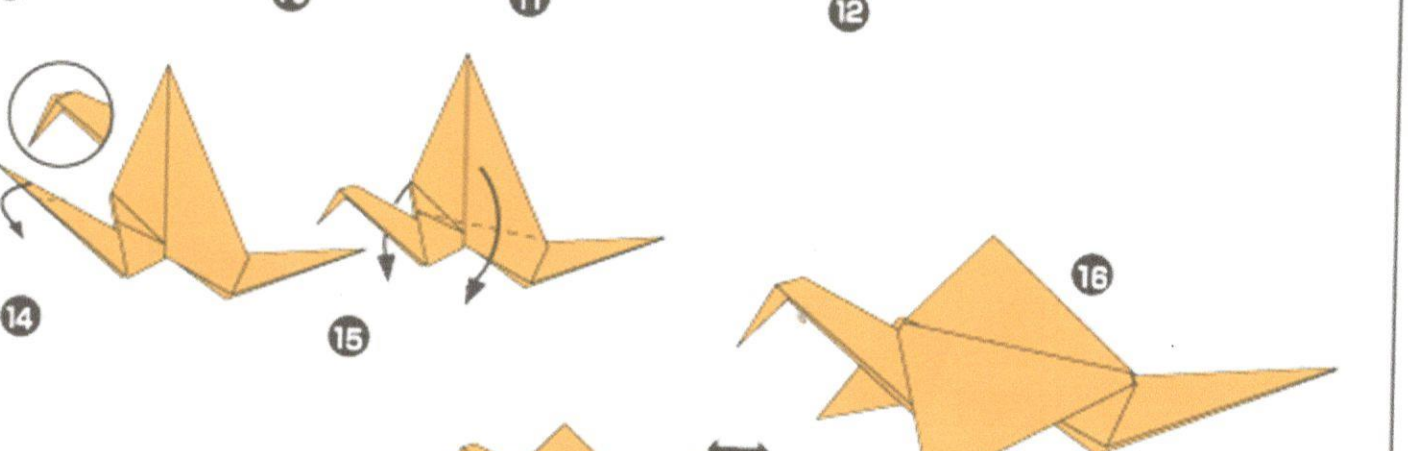
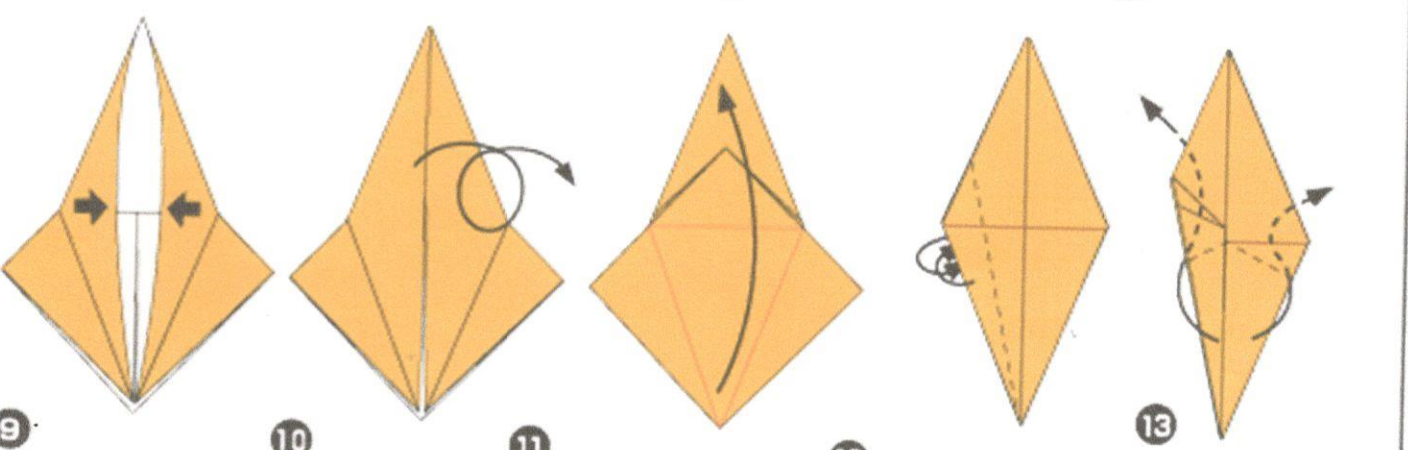
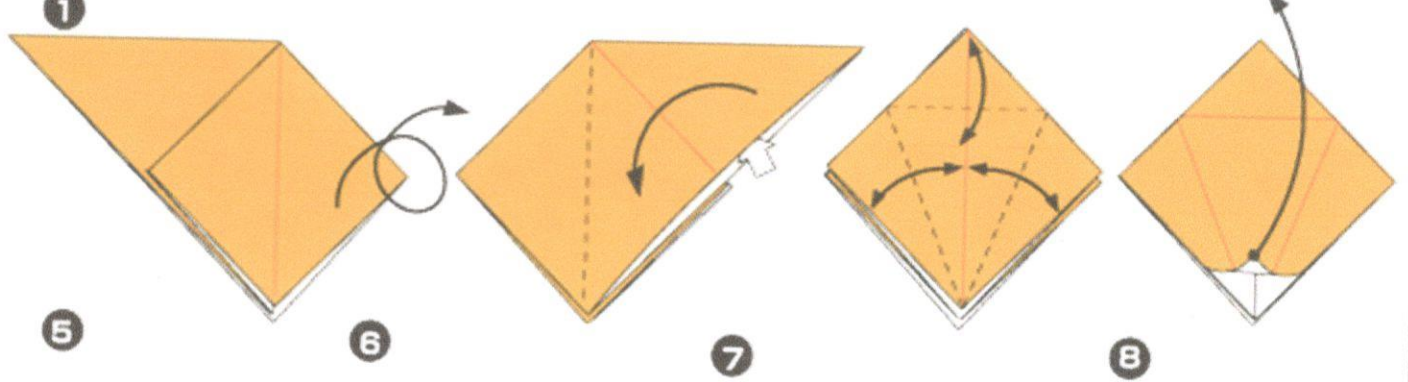
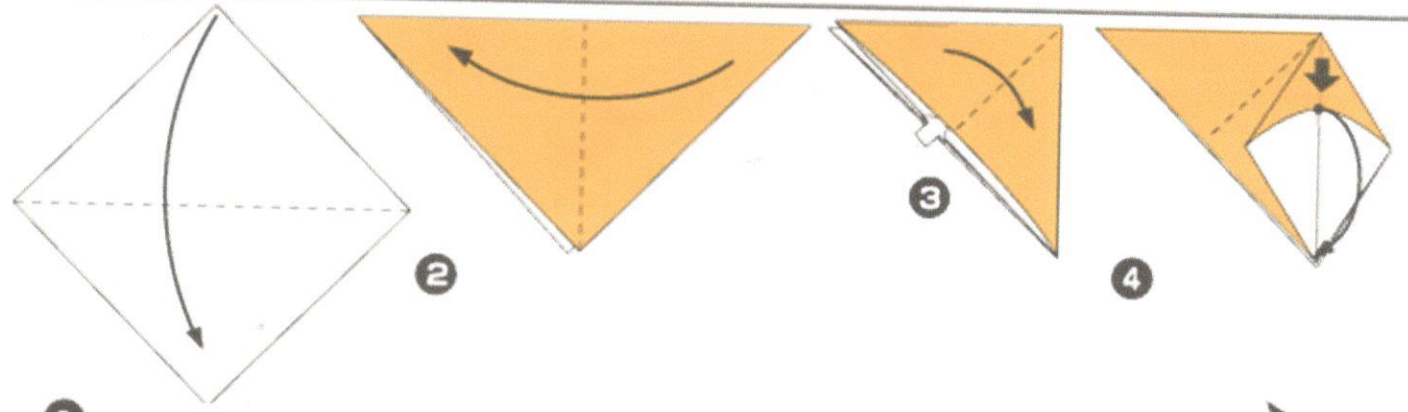

*Traditional
Diagram: Fumiaki Shingu

«ЛЯГУШКА»

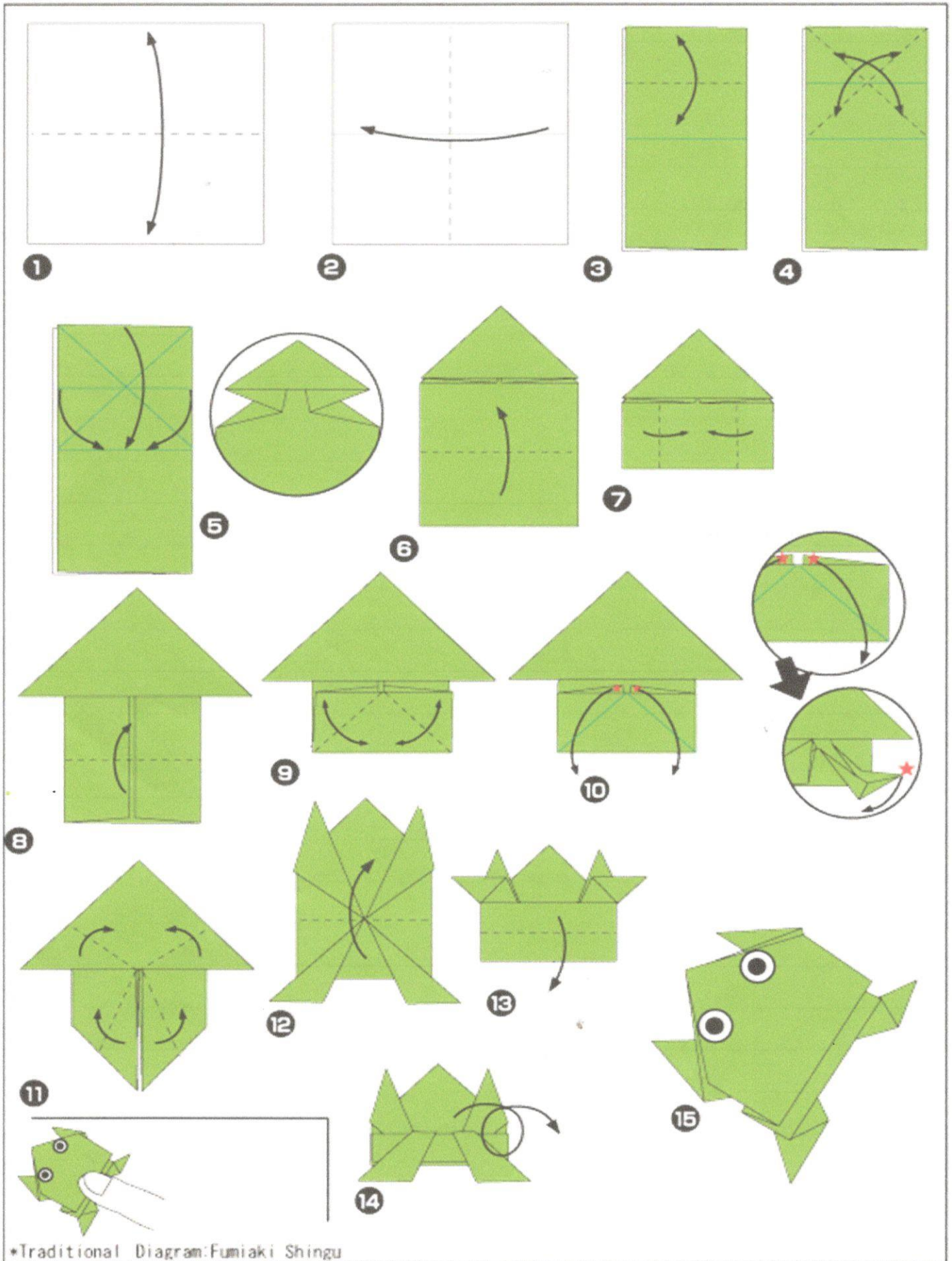

«МОРКОВЬ»

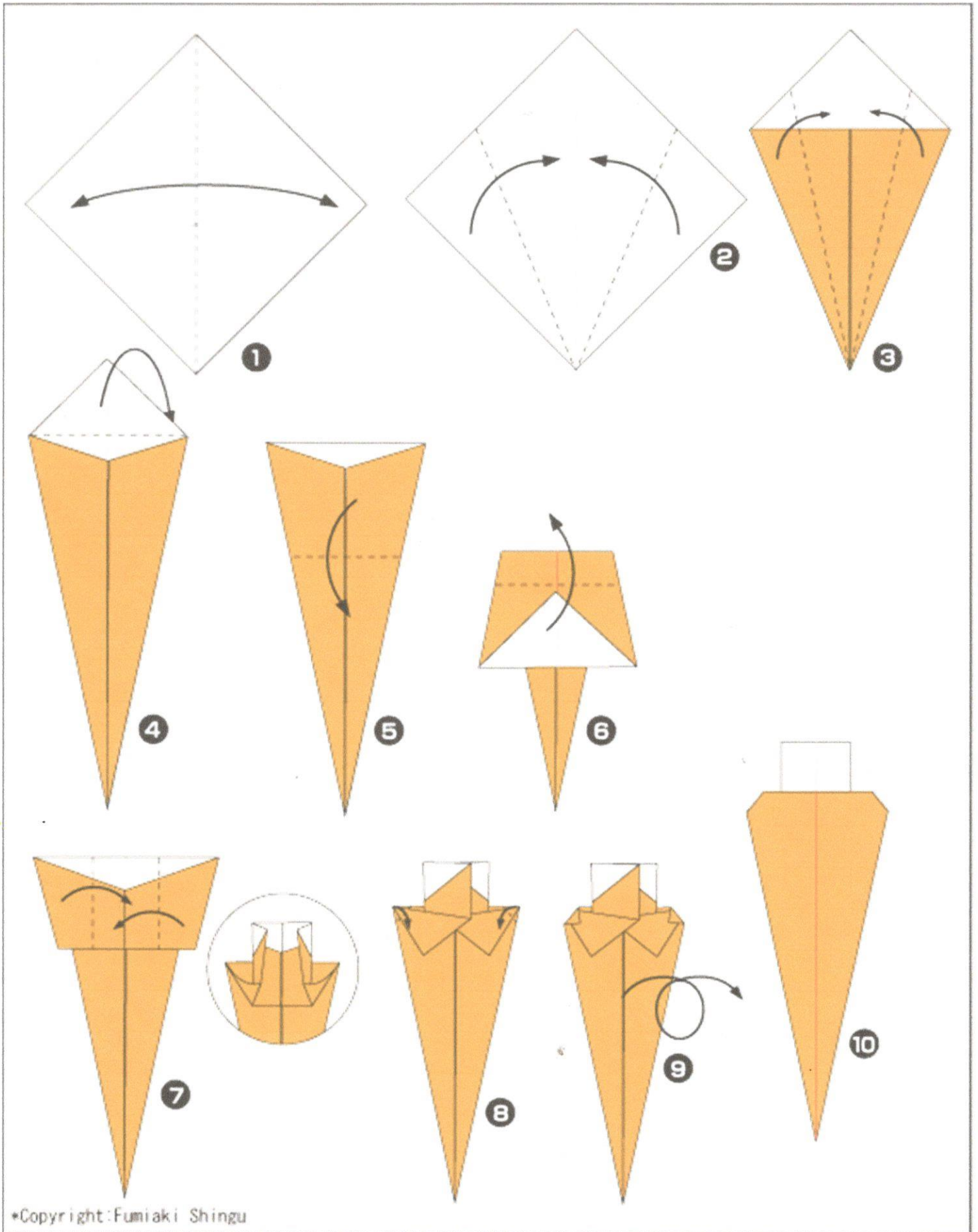

ОРИГАМИ «АКУЛА»

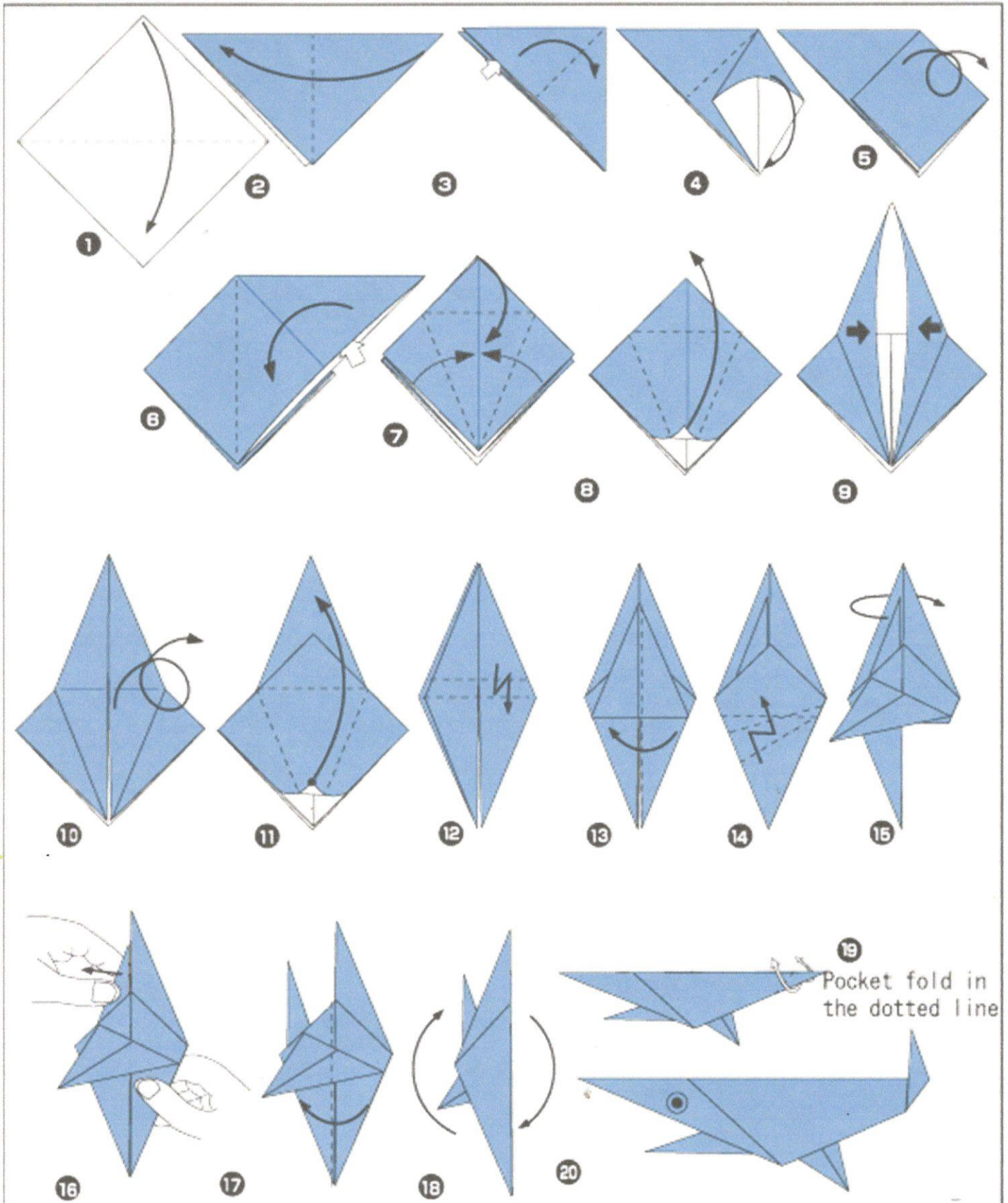

19 Pocket fold in the dotted line

ОРИГАМИ «ЧЕРЕПАХА»

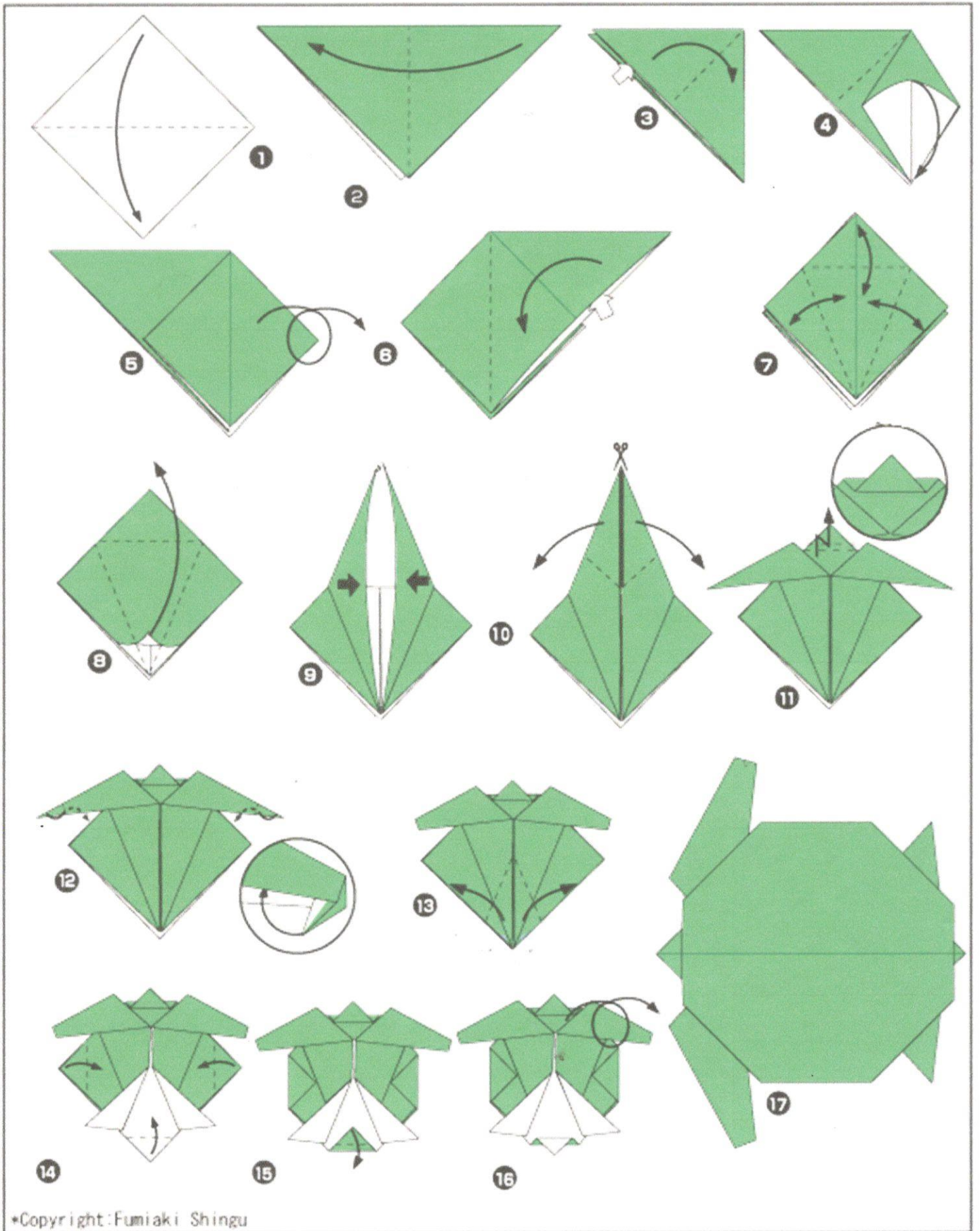

«ПАРТА»

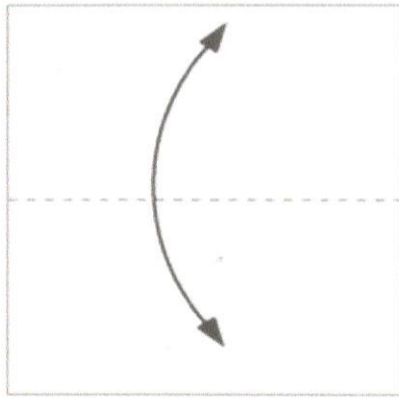

1

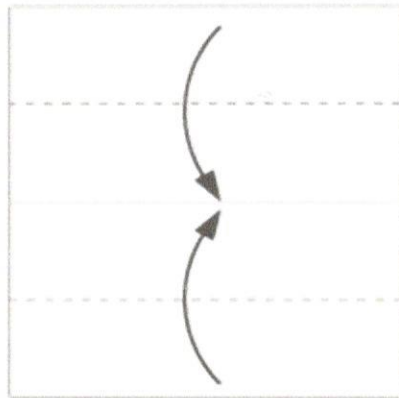

2

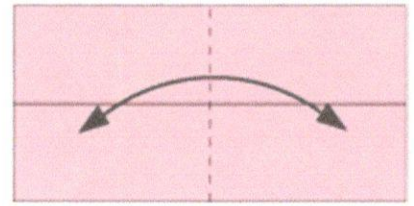

3

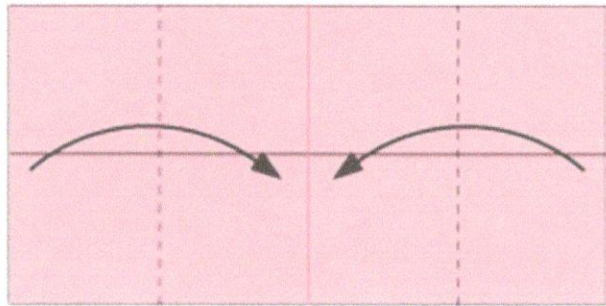

4

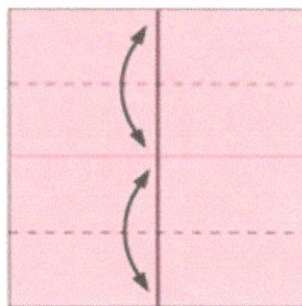

5

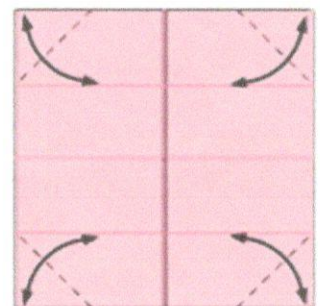

6

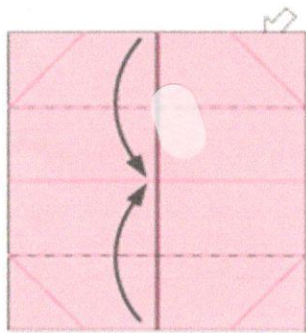

7

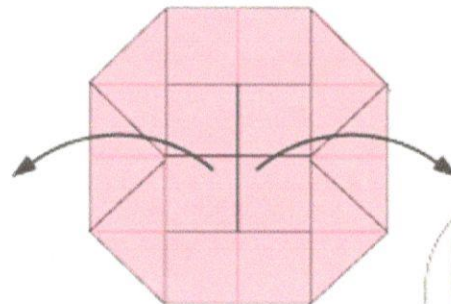
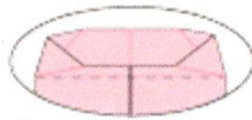

8

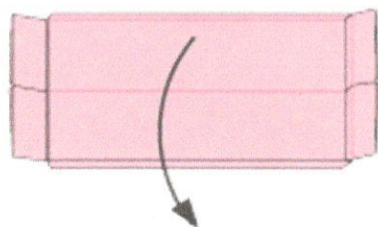
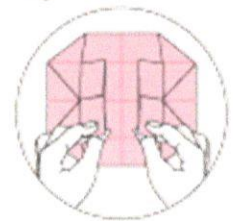

9

10

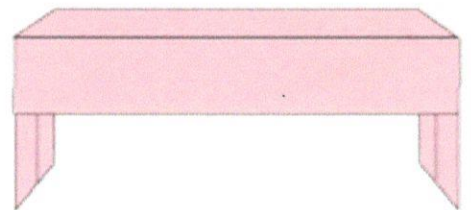

«СТОЛ»

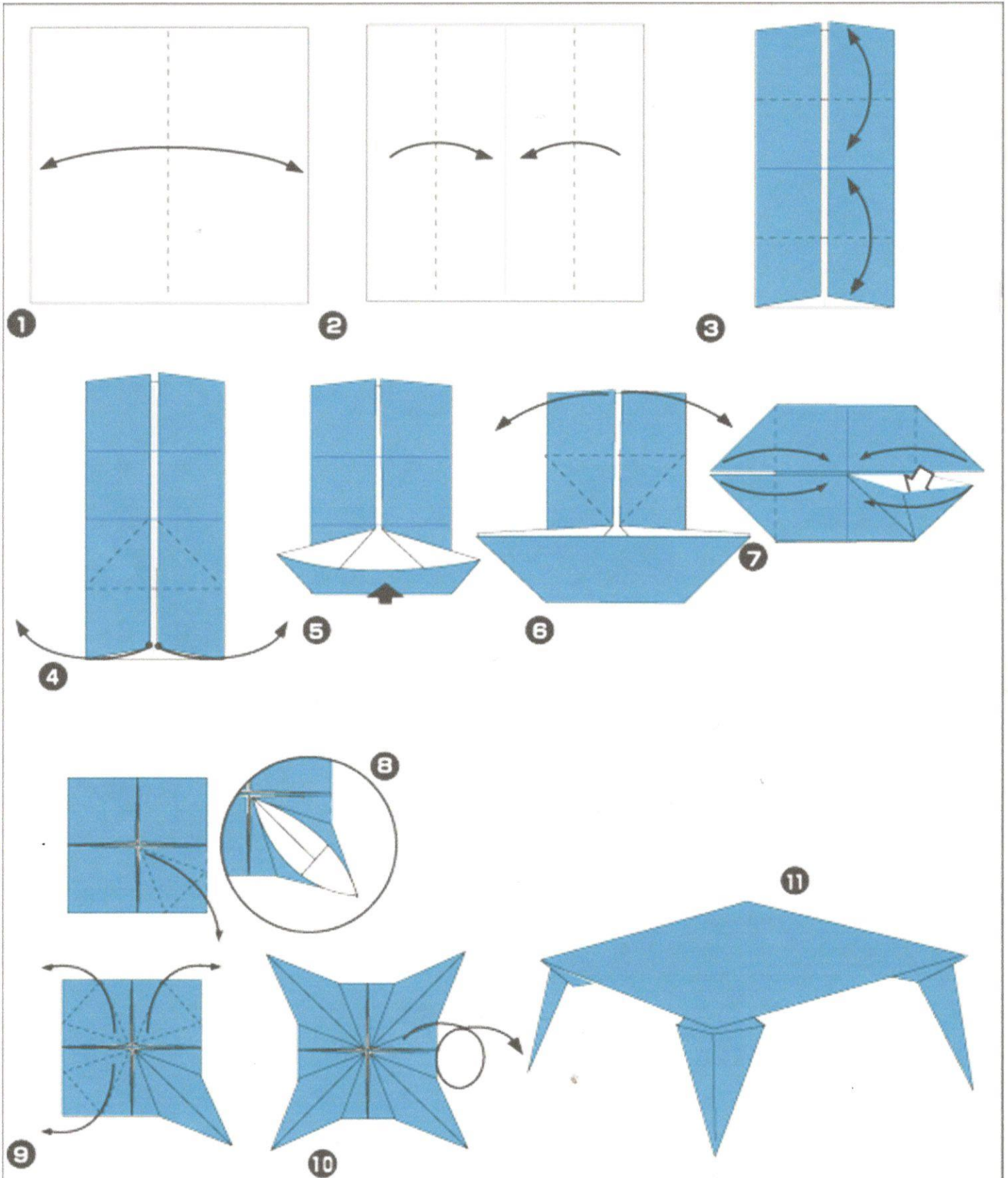

*Traditional
Diagram: Fumiaki Shingu

«КЛЕН»

